

**Lee County Board Of County Commissioners
Agenda Item Summary**

Blue Sheet No. 20030685

1. REQUESTED MOTION:

ACTION REQUESTED: Approve the award of the following project: EX030575, the purchase of modular furniture, related accessories and various furniture pieces at the Florida State Contract price of \$946,617.43 from Herman Miller Workplace for use in the new Development Services/Inspector Building. Also approve the expenditure of a not-to-exceed amount of \$95,000.00 for such incidentals as, but not limited to, miscellaneous furniture, overnight shipping, etc.

WHY ACTION IS NECESSARY: Board approval is required.

WHAT ACTION ACCOMPLISHES: Allows the Department of Public Works to obtain the necessary furnishings to open the new Development Services/Inspector Building.

**2. DEPARTMENTAL CATEGORY:
COMMISSION DISTRICT #**

C2A

3. MEETING DATE:

06-24-2003

4. AGENDA:

- CONSENT ADMINISTRATIVE APPEALS
- PUBLIC WALK ON
- TIME REQUIRED:

**5. REQUIREMENT/PURPOSE:
(Specify)**

- STATUTE
- ORDINANCE
- ADMIN. CODE AC-4-1
- OTHER

6. REQUESTOR OF INFORMATION:

- A. COMMISSIONER
 - B. DEPARTMENT Public Works
 - C. DIVISION
- BY: Jim Lavender, Director

7. BACKGROUND:

--BACKGROUND BEGINS ON PAGE TWO--

8. MANAGEMENT RECOMMENDATIONS:

9. RECOMMENDED APPROVAL:

A Department Director	B Purchasing or Contracts	C Human Resources	D Other	E County Attorney	F Budget Services				G County Manager
<i>J. Lavender</i> 6-6-03	<i>Janeet Sheehan</i> 6-6-03 <i>Rose Ambrose</i>		<i>6-6-03</i>	<i>6/9/03</i>	OA <i>6-9-03</i>	NOM <i>6/9/03</i>	Risk <i>6/9/03</i>	GC <i>6-9-03</i>	<i>J. Lavender</i> 6-6-03

10. COMMISSION ACTION:

- APPROVED
- DENIED
- DEFERRED
- OTHER

Rec. by CoAtty
Date: *6/16/03*
Time: *2:07 PM*
Forwarded to:
Co. Admin. 6/9/03 10:20 AM

RECEIVED BY
COUNTY ADMIN. *EW*
6/9 10:00
COUNTY ADMIN.
FORWARDED TO:
6/10 5:00

--BACKGROUND CONTINUED FROM PAGE ONE--

On May 14, 2003, the Division of Purchasing received a request from the Department of Public Works to prepare a request to purchase modular furniture, related accessories and various furniture pieces at the Florida State Contract price of \$946,617.43 from Herman Miller Workplace for use in the new Development Services/Inspector Building. It was also requested by Public Works that Board approval be obtained for the expenditure of a not-to-exceed amount of \$95,000.00 for such incidentals as, but not limited to, miscellaneous furniture, overnight shipping, etc.

The Division of Purchasing has verified the terms and conditions of the Florida State Contract; and will assist Public Works in obtaining any other incidental services or items that may be required.

Funding is available: 20864930100.506410 & 20864915501.506410

Please See Attachments:

- (1) Department Request for Purchases
- (2) Furniture Pricing Per Florida State Contracts No. 425-001-01-1 & No. 420-660-01-1

MEMORANDUM
FROM
THE DEPARTMENT OF
PUBLIC WORKS

ATTACHMENT #1

Date: May 12, 2003

To: Janet Sheehan
Purchasing Director

From: Jim Lavender *J. Lavender*
Public Works Director

03 MAY 14 PM 12:58

RE: Furniture Blue Sheet for Inspector Building

Please use the attached information to finalize the blue sheet to purchase furniture for the Development Services/Inspector Building. This Material Request represents furniture for the third floor. Please combine this with the Material Request that was submitted to you on May 8, 2003 for the first and second floors.

Funding is available in account strings: 20864930100.506410 and 20864915501.506410

As always, thank you for your assistance.

**MEMORANDUM
FROM
THE DEPARTMENT OF
PUBLIC WORKS**

03 MAY 12 PM 12:04

Date: May 8, 2003

To: Janet Sheehan
Purchasing Director

From: Jim Lavender *J. Lavender*
Public Works Director

RE: Furniture Blue Sheet for Inspector Building

Please use the attached information to prepare a blue sheet for the purchase of furniture for the Development Services/Inspector Building. The backup for the third floor has not been received yet. As soon as we have that information we will forward it you. The reason the backup is being piecemealed to you is to allow time for your staff to review the requests for the first two floors.

Funding is available in account string: 20864930100.506410 and 20864915501.506410

Please let me know if you need any additional information.

Furniture: Office and Files

425-001-01-1

Effective: 04/20/01 through 03/31/04

Certification
Special Conditions
Specifications
How to Use This Contract
Email the Administrator
Revisions
Complete Contract

Contractors / Price Sheets

Affordable Interior Systems, Inc.	http://www.ais-inc.com/GSANet/state.asp
Allseating	http://www.allseating.com/florida01
Allsteel, Inc.	http://www.allsteeloffice.com/Florida.html
American Seating Co.	http://www.americanseating.com/florida.htm
APW Wrightline	http://wrightline.com/florida
Artopex Plus, Inc.	http://www.burby.com/artopexstate.htm
Bodybilt, Inc.	http://www.bodybilt.com/contact/Florida/florida.htm
Canadian Atlas Furniture Corp.	http://www.burby.com/cafstate.htm
CompuChair	http://compuchairinc.com/contracts/florida.html
Cramer	http://www.cramerinc.com/florida
Dauphin North America	http://www.dauphin.com/florida/default.html
Design Options	http://www.designoptions.com/florida.htm

Design Resource Group <http://drg-macsys.com/florida>

DMI Office Furniture <http://www.dmifurniture.com/florida.htm>

Dowcraft
<http://www.dowcraft.com/gsa/contracts/florida/gsaflorida.html>

EckAdams
<http://www.EckAdams.com/state%20contract/statecontract.htm>

Executive Office Concepts <http://www.eoccorp.com/florida.htm>

Flex-Y-Plan Ind. Inc. <http://www.fyp.com/Flweb/flcontracthome.htm>

Global Ind. Inc. <http://www.globaltotaloffice.com/florida-state/>

GF Office Furniture, LTD <http://www.gfoffice.com/fl>

Groupe Lacasse USA, Inc. <http://kickme.to/Lacasse>

Gunlocke Company <http://www.gunlocke.com/GSAFlorida/>

Haworth, Inc. <http://worldresource.haworth.com/stateofflorida/>

Herman Miller, Inc. <http://www.hmiexperience.com/florida>

Hickory Leather Co. <http://www.hlc-usa.com>

HighMark <http://www.highmarkergo.com/sf1.htm>

High Point Furniture Ind. Inc. http://www.hpfi.com/state_of_fl.htm

Hon Company <http://www.hon.com/gsa/statecontract/>

Howe
<http://www.thefalconcompanies.com/government/florida/howe>

Indiana Desk Co. <http://www.indianadesk.com/floridagov/>

Invincible Metal Furniture Co. <http://invinciblefurniture.com/Florida>

ISE. Inc. <http://www.florida.ise-ergonomics.com>

JSI/Community
http://www.jasperseating.com/contracts/state_of_florida/stateofflorida_ordering.htm

Kimball / National http://www.furniture.kimball.com/gsa_florida

Knoll, Inc. <http://florida.knoll.com>

Krueger Int.(KI)

http://www.toplevelservice.com/sites/fsc/specs_main.asp

La-Z-Boy, Inc.

<http://www.lzbcontract.com/statecontracts>

Mayline Company

<http://www.mayline.com/floridacontract>

Miller Casegoods & Seating

<http://www.hackimflorida.com>

Montisa Office Furniture

<http://www.montisa.com/florida/>

Nova Solutions, Inc.

<http://www.novasolutionsinc.com/specphotos/novagovfla.html>

OFS

<http://contracts.ofs.com/florida>

Omni International, Inc.

<http://www.omniinternational.com/fl/stflcontract.html>

Packard Industries, Inc.

http://www.packardindustries.com/servicing_dealers_florida/

Paoli, Inc.

<http://www.paoli.com/statecontracts/florida.htm>

Pride Enterprises

<http://www.peol.com/state.htm>

Rosemount Office Systems, Inc.

<http://www.florida.rosemount-office.com/>

SIS Human Factor

http://www.sishft.com/florida/ordering_information.html

Sit On It Seating

<http://www.sitonit.net/home/FLContract.htm>

Sitmatic

<http://www.sitmatic.com/florida.html>

Smed International

http://www.smednet.com/html/contact/usa_florida.html

Southern Metal

<http://www.southernmetal.com/florida/>

Standard Desk

<http://www.standarddesk.com/std/myflorida.htm>

Steelcase, Inc.

<http://in2.steelcase.com/stateofflorida>

Stylex, Inc.

<http://www.stylexseating.com/stateofflorida>

Superior Furniture

<http://www.superior-seating.com/contracts/florida.htm>

Symbiote, Inc.

<http://www.symbiote.com/FloridaState>

Systematix

<http://systematix.org/flcontract.html>

Tab Products Co.	http://www.tab.com/solutions/government/florida
Teknion	http://tekfloridacontract.com
Trendway Corp.	http://www.trendway.com/contracts
Vecta	http://www.vecta.com/florida/FContract01.html
Via	http://www.viagsa.com/florida.html
Viking Acoustical Corp.	http://www.vikingusa.com/floridacontract.htm
WorkRite	http://www.wrea.com/florida



State of Florida Pricing

Herman Miller Inc.
Office Furniture and Files
State of Florida Contract # 425-001-01-1

Order volume for Products 1) on a single purchase order and 2) within the same "Special Item Numbers" (SIN's) will be aggregated to determine the proper volume pricing tier. Aggregating of products in separate SIN's and /or purchase orders is not allowed.

SIN 711-1, Systems Furniture

Price List: Commercial, August 28, 2000

Action Office and Prospects Systems Furniture, Liaison Cabinet Systems, Traverse Systems Furniture, HMI A and G Series Pedestals, Lighting, Accessories,

Net Purchase	Approx. List	Discount From List
\$100 - \$250,000	\$366 - \$915,751	72.70%
\$250,001 - \$500,000	\$915,752 - \$2,145,923	76.70%

Ethospace Systems Furniture

Net Purchase	Approx. List	Discount From List
\$100 - \$250,000	\$366 - \$915,751	71.70%
\$250,001 - \$500,000	\$915,752 - \$2,145,923	74.70%

Arrio Freestanding Systems Furniture

Net Purchase	Approx. List	Discount From List
\$100 - \$250,000	\$366 - \$915,751	69.70%
\$250,001 - \$500,000	\$915,752 - \$2,145,923	71.70%

Meridian Pedestals

Net Purchase	Approx. List	Discount From List
\$100 - \$500,000	\$366 - \$2,145,923	61.62%

HMI A and G Series Lateral Files

Net Purchase	Approx. List	Discount From List
\$100 - \$250,000	\$366 - \$915,751	57.50%
\$250,001 - \$500,000	\$915,752 - \$2,145,923	59.60%

Services:

Installation Costs Based on \$40 per hour
Space Planning Costs Based on \$55 per hour



Furniture for information processing, storage and retrieval

product showcase | dealers | kwik-ship | what's new | government | price list | free design service

**MAYLINE COMPANY &
TIFFANY INDUSTRIES
STATE of FLORIDA CONTRACT**



CONTRACT TERMS, CONDITIONS, & DISCOUNTS

MANUFACTURER'S BRAND NAME:

Mayline Group / Mayline Company, LLC

PRICE LIST NAME / NUMBER:

Mayline Company, LLC GSA Price List dated 7/1/00.

SERIES BID (Note - Each series shall be listed separately by name and/or number):

VariTask Height Adjustable Workstations, Domain Computer Furniture, Data/LAN Cabinets, Standard Data Cabinet, Maytrix LAN Computer Racking Stations.

<u>% DISCOUNT</u>	<u>STATE PURCHASE PRICE</u>
62.63%	\$0 - \$15,000 Net
63.256%	\$15,001 - \$35,000 Net
64.209%	\$35,001 - \$55,000 Net
**%	**

** (See Page 1 of Mayline GSA Price List for additional volume discounts.)

ADDITIONAL QUANTITY DISCOUNTS:

(N/A)

QUICK SHIP PROGRAMS ARE AVAILABLE FOR:

(Kwik-Ship brochure)

INSTALLATION COSTS:

*\$0 - \$2,000 Net/15%; \$2,001 - \$5,000 Net/12%; \$5,000+ Net/10%.

SPACE PLANNING COSTS:

\$45.00 / Hour

SHIPPING / DELIVERY COSTS:

Non-Installed = Standard dock to dock at N/C.
Installed Delivery = To be quoted by dealer on per product basis.
Inside Delivery Non-Installed = \$75.00 extra.

CONTRACT TERMS, CONDITIONS, & DISCOUNTS

MANUFACTURER'S BRAND NAME:

Mayline Group / Tiffany Industries.

PRICE LIST NAME / NUMBER:

Tiffany Industries, LLC GSA Price List dated 10/13/98.

SERIES BID (Note - Each series shall be listed separately by name and/or number):

Communication Station, Specialized Furniture, Generation II.	
<u>% DISCOUNT</u>	<u>STATE PURCHASE PRICE</u>
61.5%	\$0

ADDITIONAL QUANTITY DISCOUNTS:

(N/A)

QUICK SHIP PROGRAMS ARE AVAILABLE FOR:

(Kwik-Ship brochure)

INSTALLATION COSTS:

*\$0 - \$2,000 Net/15%; \$2,001 - \$5,000 Net/12%; \$5,000+ Net/10%.

SPACE PLANNING COSTS:

\$45.00 / Hour

SHIPPING / DELIVERY COSTS:

Non-Installed = Standard dock to dock at N/C.
Installed Delivery = To be quoted by dealer on per product basis.
Inside Delivery Non-Installed = \$75.00 extra.

© 1996-2001 **MAYLINE GROUP All Rights Reserved**

Website Design Provided by Zimmerman Design Office
Website Hosting Provided by Excel.Net Inc.

Self-contained steel C-Files® have integral cap and can be bolted together for stacking. Drawers have front metal plan depressor and rear hood to keep documents flat and orderly. (Dust covers optional.) High base designed to support one file.
Standard paint finishes: Sand Beige, White, Black, Gray

MAYLINE

7867-68-69
C-FILE

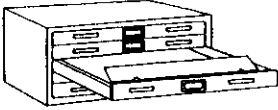

Flush Base

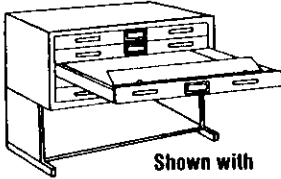

Shown with
High Base

Mayline Self-Contained Steel C-Files®		Overall Unit Sizes			Inside Drawer Sizes			Wt.	List Price
Model No.		W	H	D	W	H	D		
7867C	Five-Drawer File for 24" x 36" sheets	40 3/4"	15 3/8"	28 3/8"	37"	2"	25 3/4"	170#	\$1013
7867D	Five-Drawer w/Dust Cover for 24" x 36" sheets	40 3/4"	15 3/8"	28 3/8"	37"	2"	25 3/4"	177#	\$1125
7977C	Ten-Drawer File for 24" x 36" sheets	40 3/4"	15 3/8"	28 3/8"	37"	5/8"	25 3/4"	210#	\$2098
7977D	Ten-Drawer w/Dust Covers for 24" x 36" sheets	40 3/4"	15 3/8"	28 3/8"	37"	5/8"	25 3/4"	216#	\$2369
7877	20" High Base with Bookshelf for 24" x 36" size file	40 3/4"	20"	28 3/8"	33 3/4"	-	14 1/2"	52#	\$393
7867W	Flush Base for 24" x 36" size file	40 3/4"	4"	28 3/8"	-	-	-	14#	\$177
7868C	Five-Drawer File for 30" x 42" sheets	46 3/4"	15 3/8"	35 3/8"	43"	2"	32 3/4"	220#	\$1177
7868D	Five-Drawer File w/Dust Covers for 30" x 42" sheets	46 3/4"	15 3/8"	35 3/8"	43"	2"	32 3/4"	229#	\$1290
7978C	Ten-Drawer File for 30" x 42" sheets	46 3/4"	15 3/8"	35 3/8"	43"	5/8"	32 3/4"	305#	\$2186
7978D	Ten-Drawer w/Dust Covers for 30" x 42" sheets	46 3/4"	15 3/8"	35 3/8"	43"	5/8"	32 3/4"	310#	\$2476
7878	20" High Base with Bookshelf for 30" x 42" size file	46 3/4"	20"	35 3/8"	44 3/4"	-	14 1/2"	63#	\$417
7868W	Flush Base for 30" x 42" size file	46 3/4"	4"	35 3/8"	-	-	-	16#	\$196
7869C	Five-Drawer File for 36" x 48" sheets	53 3/4"	15 3/8"	41 3/8"	50"	2"	38 3/4"	275#	\$1404
7869D	Five-Drawer File w/Dust Covers for 36" x 48" sheets	53 3/4"	15 3/8"	41 3/8"	50"	2"	38 3/4"	279#	\$1517
7979C	Ten-Drawer File for 36" x 48" sheets	53 3/4"	15 3/8"	41 3/8"	50"	5/8"	38 3/4"	365#	\$2601
7979D	Ten-Drawer w/Dust Covers for 36" x 48" sheets	53 3/4"	15 3/8"	41 3/8"	50"	5/8"	38 3/4"	350#	\$2956
7879	20" High Base with Bookshelf for 36" x 48" size file	53 3/4"	20"	41 3/8"	51 3/4"	-	14 1/2"	70#	\$434
7869W	Flush Base for 36" x 48" size file	53 3/4"	4"	41 3/8"	-	-	-	18#	\$237

Work Chair *continued*

Aeron® Work Chairs

P	W	\$1065	1065	1065
F		\$1105	1105	1105
P		\$1105	1105	1105
H	W	\$1100	1100	1100
F		\$1140	1140	1140
P		\$1140	1140	1140
A	W	\$1130	1130	1130
F		\$1170	1170	1170
P		\$1170	1170	1170

Step 4: Support Options

For standard tilt (1)

N2	no additional support	+\$0
AJ	adjustable lumbar support	+\$50

For tilt limiter (2) or tilt limiter and seat angle (3)

N2	no additional support	+\$0
AJ	adjustable lumbar support	+\$50
PI	adjustable PostureFit™ support	+\$90

Step 5: Base/Frame Finish

For a size (A)

G1	graphite	+\$0
----	----------	------

For b size (B) or c size (C)

G1	graphite	+\$0
ZB	graphite with frame applique	+\$134

BB	2 1/2" hard double wheel caster, carpet	+\$0
GF	2 1/2" glide, hard floors or carpet <input type="checkbox"/>	+\$0
C7	2 1/2" double wheel caster, hard floors or carpet	+\$35
CB	2 1/2" hard double wheel braking caster, carpet	+\$35
C9	2 1/2" double wheel braking caster, hard floors or carpet <input type="checkbox"/>	+\$35
BX	3" hard double wheel caster, carpet	+\$84
DX	3" soft tread double wheel caster, hard floors or carpet <input type="checkbox"/>	+\$105

Step 6: Arm Pads

BK	black	+\$0
----	-------	------

Price Category 1	+\$0
------------------	------

Price Category 1	+\$0
------------------	------

For fixed arms (P) with fabric arm pads (F), height-adjustable arms (H) with fabric arm pads (F), or fully adjustable arms (A) with fabric arm pads (F)

Price Category 1	+\$0
Price Category 2	+\$0
Price Category 3	+\$0
Price Category 4	+\$0
Price Category 5	+\$0
Price Category 6	+\$0
Price Category 7	+\$0
Price Category 8	+\$60
Price Category B	+\$13
Price Category E	+\$32
Price Category F	+\$44
Price Category G	+\$56
Price Category H	+\$75

For fixed arms (P) with perspectives® collection arm pads (P), height-adjustable arms (H) with perspectives® collection arm pads (P), or fully adjustable arms (A) with perspectives® collection arm pads (P)

Price Category 3	+\$0
Price Category 4	+\$0

Stacking Side Chair

AD10P
AD10U

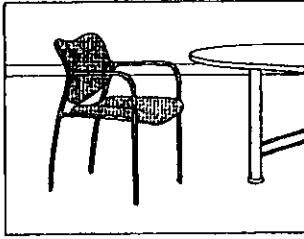

Product Information

Description

This chair has thick foam padding, a contoured seat cushion, an upholstered or nonupholstered outer back, waterfall edges, and a 4-leg, wall-protecting base. Chairs can stack 5 high on the floor.

Each chair complies with the following standards:

- ANSI/BIFMA - 5.1 - 1993 safety and durability standard
- California Technical Bulletin 117 fire safety standard

Notes

For chair used on carpet, glide (SG) option is recommended. For chair used on hard floor, glide with insert (HG) is recommended.

Chair accepts Customer's Own Material (COM); fully upholstered chair requires 1 3/4 yards; nonupholstered-back chair requires 1 yard. See Order Information in Appendices.

Dimensions

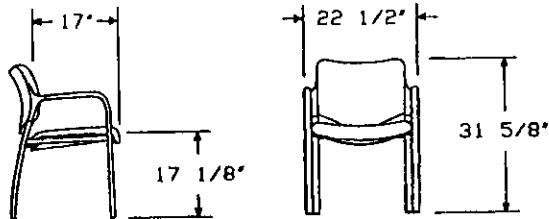

LEAF FABRIC
IS GRADE 5

Specification Information

Step 1:

AD10

Step 2: Outer Back

- PB nonupholstered outer back
- UB upholstered outer back

Step 3: Arms

- AD10PB
- AD10UB
- MA metal arms +\$0

Step 4: Glide Option

- SG glide +\$0
- HG glide with insert +\$7

Step 5: Frame Finish

- BK black +\$0
- MS metallic silver +\$0
- MT medium tone +\$0

Step 6: Fabric

See Price Category chart and textiles list for fabric usage and numbers. First three digits indicate fabric line; remaining digit(s) indicate fabric color.

- Price Category 1 +\$0
- Price Category 2 +\$10
- Price Category 3 +\$36
- Price Category 4 +\$64
- Price Category 5 +\$104
- Price Category 6 +\$135
- Price Category 7 +\$143

LIST: \$390

Aside Side Chairs

\$267
\$386



**NATIONAL OFFICE FURNITURE CASEGOODS PRICE SHEET
CONTRACT 425-001-01-1**

CASEGOOD SERIES NAME	PRICE LIST	PURCHASE PRICE(LIST)	NET \$ RANGE	% DISCOUNT
BARRINGTON, FRANKLIN, ESCALADE, HILAND, CLEVER ARROWOOD 3100, ARROWOOD 2100, ENVY, WAVEWORKS TABLES ACCESSORIES BOOKCASES FILES	FORM # NGSAPL-02	\$0-\$757,576 \$757,577- 1,288,660	\$0-300,000 \$300,001-500,000	60.4 61.2

**QUICK SHIP PROGRAMS ARE AVAILABLE FOR:
DESIGNATED PRODUCTS, PER GSA PRICE LIST**

**INSTALLATION COST:
TO BE QUOTED ON A PROJECT-BY-PROJECT BASIS**

**SPACE PLANNING COST:
\$55.00 PER HOUR**

**SHIPPING/DELIVERY COST:
F.O.B. DESTINATION. INSIDE DELIVERY QUOTED ON A PER JOB BASIS**



NATIONAL

Furniture with Personality™

**NATIONAL OFFICE FURNITURE SEATING PRICE SHEET
CONTRACT 425-001-01-1**

SEATING SERIES NAME	PRICE LIST	PURCHASE PRICE(LIST)	NET \$ RANGE	% DISCOUNT
ARLINGTON,	FORM #	\$ 0-\$252,525	\$ 0-100,000	60.4
CINCH,	NGSAPL-02	\$252,526-515,464	\$ 100,001-200,000	61.2
GOTCHA,		\$515,465-781,250	\$ 200,001-300,000	61.6
JOURNEY,				
JUSTICE,				
MEDALIST,MIX-IT				
PENNANT,				
PENNANT LOUNGE,				
PREFERA,REMEDY				
RENO, TAG,				
TIMBERLAKE,				
TORREY & TRIUMPH				

QUICK SHIP PROGRAMS ARE AVAILABLE FOR:
DESIGNATED PRODUCTS, PER GSA PRICE LIST

INSTALLATION COST:
TO BE QUOTED ON A PROJECT-BY-PROJECT BASIS

SPACE PLANNING COST:
\$55.00 PER HOUR

SHIPPING/DELIVERY COST:
F.O.B. DESTINATION. INSIDE DELIVERY QUOTED ON A PER JOB BASIS



Contract # 425-001-01-1

Kimball Office

✓ DISCOUNT

✓ VOLUME TIERS

✓ INSTALLATION

✓ SPACE PLANNING

✓ SHIPPING/DELIVERY

PRESENTATION CABINET AND ACCESSORIES

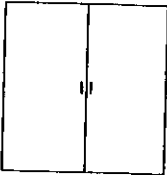
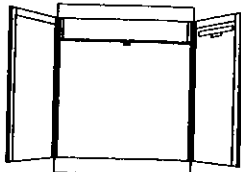
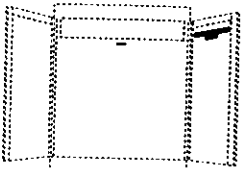
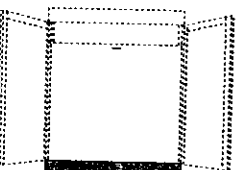
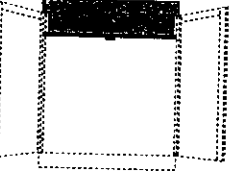
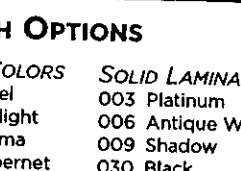
PRODUCT	MODEL #	DIMENSION/DESCRIPTION	SHIP WT.	PRICE
	PPCSL34	Presentation Cabinet w/Marker Set 48"H x 48"W x 3"D (122 x 122 x 8 cm)	130 lbs / 59 kg	
	PPCLD34	Loaded Presentation Cabinet with Tool Cubby, Right Side Flip Chart Holder, Screen 48"H x 48"W x 3"D (122 x 122 x 8 cm)	166 lbs / 75 kg	
	PPCFCRT	Flip Chart Holder for right side of cabinet	12 lbs / 5 kg	\$95.00
	PPCFCLF	Flip Chart Holder for left side of cabinet	12 lbs / 5 kg	\$95.00
NOTE: Must be ordered with Presentation Cabinet.				
	PPCTOOL	Presentation Cabinet Tool Cubby	12 lbs / 5 kg	\$160.00
NOTE: Must be ordered with Presentation Cabinet.				
	PPCSNMT	Presentation Cabinet Screen	14 lb / 6 kg	\$153.00
NOTE: Must be ordered with Presentation Cabinet.				

FINISH OPTIONS

BASE COLORS	SOLID LAMINATES	PATTERNED LAMINATES	169 Charcoal Fusion	WOOD LAMINATES	WOOD VENEERS
EF Eiffel	003 Platinum	015 Grey Moraine	170 Ochre Tempera	031 Fusion Maple	062 Natural Oak
TW Twilight	006 Antique White	016 Grey Nebula	263 Clay Roletta	032 Wild Cherry	063 Dark Oak
KM Karma	009 Shadow	018 Storm Nebula	269 Umber Tempera	049 Mahogany	067 Medium Oak
CB Cabernet	030 Black	019 Grey Glace	272 Paris White	075 Solar Oak	072 Natural Cherry
VN Venus	045 Putty	020 White Nebula	286 Charcoal Essence	102 Banister Oak	077 Medium Cherry
QZ Quartz	050 Grey (Quartz)	021 Cloud Nebula	301 Saffron Tigris	303 Golden Anagre	078 Chau Cherry
CH Champagne	454 Provence Pear	029 Natural Nebula	417 Creme Tranquility	324 Amber Maple	079 Retro Cherry
GP Graphite	456 Shadow Blue	042 Bronze Legacy	466 Pewter Brush	336 Regency Mahogany	082 Natural Maple
CP Cappuccino	468 Maritime Grey	051 Graphite Nebula	474 Gray Tranquility	399 Select Cherry	090 Sapeli
AN Anthracite	469 Wrought Iron	060 Grey Tigris	561 Limestone	458 Manitoba Maple	
TZ Topaz	477 Neutral White	144 Green Legacy	597 Metallic Gauze	459 Windswept	TRIM COLORS
PL Polo	605 Larkspur	150 Navy Legacy	653 Silver Alu Metalx	461 Windswept Pewter	Q Quartz
CD Cardinal	632 Bone White	159 Maize Shiori	654 Copper Gauze	472 Champagne Sagawood	K Cappuccino
RN Raven	647 California	164 Smoke Essence	655 Jute Gauze	473 Grand Isle Maple	A Anthracite
AR Arctic	649 Cool Rock	168 Aluminite	656 Flax Gauze	658 Cocoa Maple	C Cardinal
SD Sand	650 Garden Mist		657 White Essence	660 Natural Cherry	R Raven
BP Black Pumice					M Aluminum
OX Onyx					V Vellum
PT Pewter					
AL Aluminum					

LAMINATE	VENEER
\$1641.00	\$1996.00
\$2047.00	\$2402.00

HOW TO ORDER PRESENTATION CABINETS:

Example: Presentation Cabinet; Charcoal Fusion Laminate;
Cappuccino Paint.

PPCSL34 169 CP
Model Number Laminate or Veneer Base Color

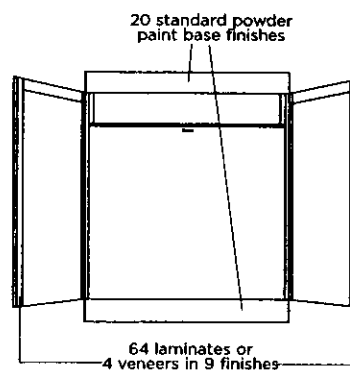

MEDIA TOWER

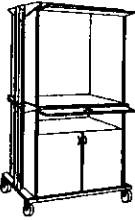
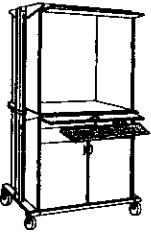
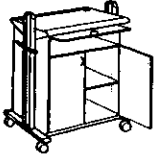
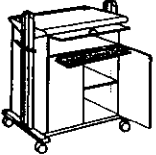
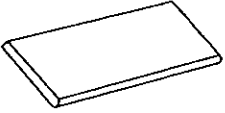
PRODUCT	MODEL #	DIMENSION/DESCRIPTION	SHIP WT.	LIST PRICE
	PMT7644	Media Tower 77"H x 32"D x 53"W (196 x 81 x 135cm)	680 lbs / 309 kg	
		NOTE: Ships fully assembled.		
	PMTPARM	Media Tower with Keyboard Arm 77"H x 32"D x 53"W (196 x 81 x 135cm)	698 lbs / 181 kg	
		NOTE: Ships fully assembled.		
	PMTC45	Convertible Media Tower 45"H x 32"D x 53"W (114 x 81 x 135 cm)	434 lbs / 197 kg	
		NOTE: Ships fully assembled.		
	PMTCRM	Convertible Media Tower with Keyboard Arm 45"H x 32"D x 53"W (114 x 81 x 135 cm)	318 lbs / 146 kg	
		NOTE: Ships fully assembled.		
	PCAM	VideoConference Camera Shelf 14 ¹ / ₄ "W x 10 ³ / ₄ "D x 1 ¹ / ₈ "H (36 x 27 x 3 cm) Hooks onto top shelf of Convertible Media Tower and Media Tower	6 lbs / 3 kg	\$90.00

FINISH OPTIONS

BASE COLORS	SOLID LAMINATES	PATTERNED LAMINATES		WOOD LAMINATES	WOOD VENEERS
EF Eiffel	003 Platinum	015 Grey Moraine	169 Charcoal Fusion	031 Fusion Maple	062 Natural Oak
TW Twilight	006 Antique White	016 Grey Nebula	170 Ochre Tempera	032 Wild Cherry	063 Dark Oak
KM Karma	009 Shadow	018 Storm Nebula	263 Clay Roletta	049 Mahogany	067 Medium Oak
CB Cabernet	030 Black	019 Grey Glace	269 Umber Tempera	075 Solar Oak	072 Natural Cherry
VN Venus	045 Putty	020 White Nebula	272 Paris White	102 Banister Oak	077 Medium Cherry
QZ Quartz	050 Grey (Quartz)	021 Cloud Nebula	286 Charcoal Essence	303 Golden Anagre	078 Chau Cherry
CH Champagne	454 Provence Pear	029 Natural Nebula	301 Saffron Tigris	324 Amber Maple	079 Retro Cherry
GP Graphite	456 Shadow Blue	042 Bronze Legacy	417 Creme Tranquility	336 Regency Mahogany	082 Natural Maple
CP Cappuccino	468 Maritime Grey	051 Graphite Nebula	466 Pewter Brush	399 Select Cherry	090 Sapeli
AN Anthracite	469 Wrought Iron	060 Grey Tigris	474 Gray Tranquility	458 Manitoba Maple	
TZ Topaz	477 Neutral White	144 Green Legacy	561 Limestone	459 Windswept	TRIM COLORS
PL Polo	605 Larkspur	150 Navy Legacy	597 Metallic Gauze	461 Windswept Pewter	Q Quartz
CD Cardinal	632 Bone White	159 Maize Shibori	653 Silver Alu Metalx	472 Champagne Sagawood	K Cappuccino
RN Raven	647 California	164 Smoke Essence	654 Copper Gauze	473 Grand Isle Maple	A Anthracite
AR Arctic	649 Cool Rock	168 Aluminite	655 Jute Gauze	658 Cocoa Maple	C Cardinal
SD Sand	650 Garden Mist		656 Flax Gauze	660 Natural Cherry	R Raven
BP Black Pumice			657 White Essence		M Aluminum
OX Onyx					V Vellum
PT Pewter					
AL Aluminum					

LAMINATE	VENEER
3MM PVC	3MM HW
\$4610.00	\$5657.00
\$4979.00	\$6050.00
\$2094.00	\$3749.00
\$2464.00	\$4120.00

MEDIA TOWERS
 800.521.0674

HOW TO ORDER MEDIA TOWER:
 Example: Media Tower with Cabinet; Quartz Base Color;
 Storm Nebula Laminate Cabinet; Quartz Trim.

PMT7644 **QZ** **018** **Q**
Model Number Base Color Laminate or Veneer Trim Color

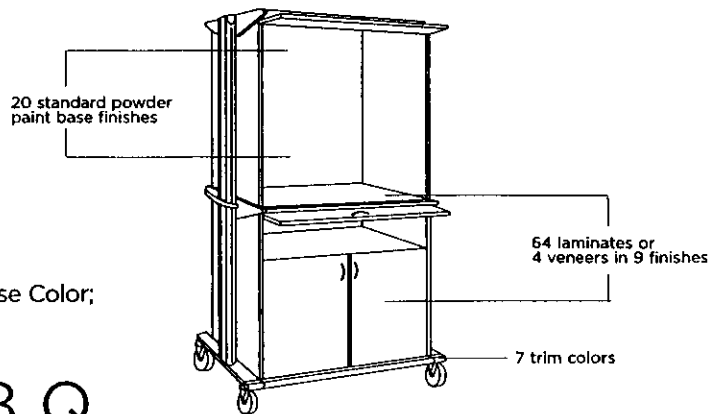

PE

Squared-Edge Transaction
Surface, Rectangular End *continued*

Ethospace® Work Surfaces

Specification Information

E2812.

Widths

- 24L 24" wide
- 30L 30" wide
- 36L 36" wide
- 42L 42" wide
- 48L 48" wide

Cutouts

- N no cutout
- C cutout on one end

Price Table

	N	C
E2812. 24L	\$177	197
30L	\$183	203
36L	\$198	218
42L	\$206	226
48L	\$212	232

Color Options

Solid-Color Laminate Top/Vinyl Edge

BQ	folkstone grey	+\$0
BU	black umber	+\$0
CL	cool grey neutral	+\$0
HF	inner tone light	+\$0
LU	soft white	+\$0
WL	sandstone	+\$0
WN	warm grey neutral	+\$0

Fiber Laminate Top/Vinyl Edge

1X	vanilla	+\$0
2X	wheat	+\$0
3X	celery	+\$0
4X	coriander	+\$0
5X	chamomile	+\$0
6X	cinnamon	+\$0
7X	cardamom	+\$0
8X	kale	+\$0

Frosted Laminate Top/Vinyl Edge

J4	frosted light grey	+\$0
J5	frosted inner tone light	+\$0
J6	frosted slate grey	+\$0
J7	frosted medium tone	+\$0
J8	frosted black	+\$0

Patterned Laminate Top/Vinyl Edge

N1	grey nebula	+\$0
----	-------------	------

Wood-Grain Laminate Top/Vinyl Edge

LA	light ash	+\$0
LM	mahogany	+\$0

ATTN: PATTI

Energy Efficient Task Light

G6120.
G6121.
G6123.

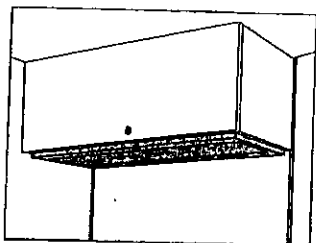

Product Information

Description

This light mounts under a flipper door unit or shelf to uniformly light a work surface. It has an electronic ballast, T8 lamp with a 3500° Kelvin color temperature, and batwing lens. The light is UL listed and CSA certified. Mounting hardware and 3 cord management clips are included.

The 24"-wide light includes 1 preheat fluorescent lamp; 30" to 60"-wide lights include 1 rapid-start fluorescent lamp.

Notes

Light tone (LT) and neutral light (LN) finishes are not available on Ethospace® products.

Dimensions

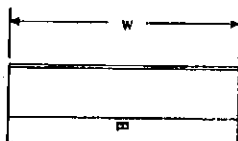
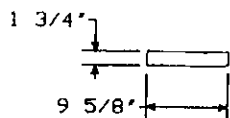

Specification Information

Step 1

G612

Step 2 Code Requirements

- 0. meets local codes including Canada
- 1. meets Chicago codes
- 3. meets New York City codes

Step 3 Width

- 24M 24" wide
- 30M 30" wide
- 36M 36" wide
- 42M 42" wide
- 48M 48" wide
- 60M 60" wide

Step 4 Ballast

For 24" wide (24M)

G high-power-factor magnetic ballast

For 30" wide (30M), 36" wide (36M), 42" wide (42M), 48" wide (48M), or 60" wide (60M)

E electronic ballast

Step 5 Dimmer

For 24" wide (24M) with high-power-factor magnetic ballast (G)

N no dimmer

For 30" wide (30M) with electronic ballast (E), 36" wide (36M) with electronic ballast (E), 42" wide (42M) with electronic ballast (E), 48" wide (48M) with electronic ballast (E), or 60" wide (60M) with electronic ballast (E)

N no dimmer

D 3-step dimmer

Prices for Steps 1-5

	N	D
G6120. 24M G	\$200	—
30M E	\$243	288
36M E	\$249	294
42M E	\$261	306
48M E	\$267	312
60M E	\$292	337

Ethospace® Lighting

Furniture: Conference/Public Area

420-660-01-1

Effective: 04/20/01 through 03/31/04

Certification
Special Conditions
How to Use This Contract
Revisions
Email the Administrator
Complete Contract

Contractors / Price Sheets

August, Inc.	http://www.augustinc.com/statecontracts/florida.htm
Berco Tableworks	http://www.bercoinc.com/contact/florida_contract.php
Brandrud Furniture	http://www.brandrud.com/contracts.html
Brayton International	http://brayton.com/florida_state/index.htm
Cabot Wrenn	http://www.cwflorida.com
Carolina Business Furniture:	http://www.carolinabusinessfurn.com
ChromCraft Business Furniture	http://www.chromcraftcontract.com/floridacontract
Dar/Ran Furniture	http://www.darranfla.com
Davis Furniture	http://www.davisfurniture.com/florida
Egan Visual	http://www.egan.com/florida

ERG International	http://www.erginternational.com/cfml/florida.cfm
Fairfield Chair Co.	http://www.floridafairfield.com
Falcon Products, Inc.	http://www.thefalconcompanies.com/government/florida
Group Four Furniture	http://www.members.aol.com/g4furn/florida.htm
Integra, Inc.	http://www.integraseating.com/florida
Johnson Industries	http://www.thefalconcompanies.com/government/florida
/jo/	
Leathercraft	http://www.geocities.com/leathercraftfla
Miller Casegoods & Seating	http://www.hackimflorida.com
Nightingale, Inc.	http://www.geocities.com/nightingalefla
Nucraft Furniture	http://www.nucraft.com/html/stateofflorida.htm
Patrician Furniture	http://florida.patrician.com
Shelby Williams	http://www.shelbywilliams.com/shelbyflorida.html
Steelcase, Inc.	http://in2.steelcase.com/stateofflorida
St. Timothy	http://www.sttimothychair.com/govfla
Thonet Industries	http://www.thefalconcompanies.com/government/florida
/thonet/	
Trinity Furniture	http://www.burby.com/trinitystate.htm
Versteel	http://www.versteel.com/statecontracts
Wieland Furniture, Inc.	http://www.wielandfurniture.com/contracts/florida-
ps.shtml	

FLORIDA STATE CONTRACT**PRICE SHEET**Dealer listings by area | Ordering Instructions**Brand Name Bid: Group Four Furniture Inc.****Price List Name / Number: Retail Price List 1993****Fixed Discount from List Prices: 53% off Retail List Prices****Additional Quantity Discounts:**

List additional discounts applicable to any single order of any combination of awarded contract items to be delivered at one time to one destination. Prices listed below are Net Prices, inclusive of fixed discount:

\$ 3,500 to \$ 4,999	0.0%	\$100,000 to \$199,999	5.0%
\$ 5,000 to \$ 9,999	0.0%	\$200,000 to \$249,999	6.0%
\$ 10,000 to \$ 19,999	1.0%	\$250,000 to \$299,999	6.0%
\$ 20,000 to \$ 24,999	1.0%	\$300,000 to \$349,999	7.0%
\$ 25,000 to \$ 49,999	2.0%	\$350,000 to \$399,999	7.0%
\$ 50,000 to \$ 74,999	3.0%	\$400,000 to \$499,999	8.0%
\$ 75,000 to \$ 99,999	4.0%	\$500,000 or more	9.0%

Quick Ship Programs: All products can be shipped on a short lead time, if necessary. Please contact us with specific requirements.

Installation Costs: 5 % of Net Cost of Items

Space Planning Costs: CAD services included in above pricing. For more comprehensive space planning or consultation, a cost per project will be established.

Shipping / Delivery Costs: Included

Group Four Furniture Inc.
 33 Shepherd Road
 Oakville, Ontario
 L6K2G6
 toll free:(877) 585-1478
 tel:(905) 845-0211
 fax:(905) 845-6894
g4furn@aol.com

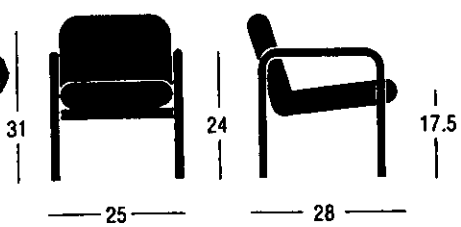

3403
Stable

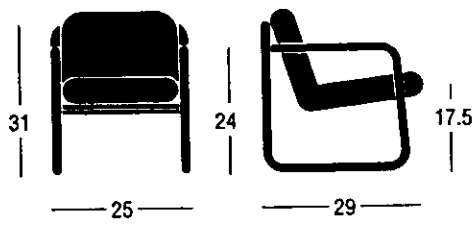

3503
Continuum

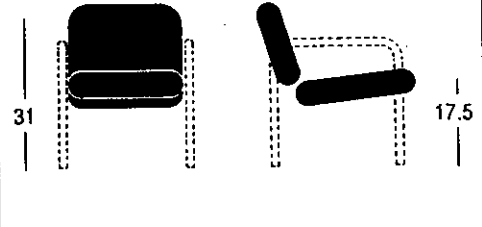

3403S, 3503S
Split Seat and Back

EPOXY		CHROME	EPOXY		CHROME	EPOXY		CHROME
422		530	468		592	+100		+110
450		558	496		620	+100		+110
466		574	<u>512</u>		636	<u>+100</u>		+110
490		598	<u>536</u>		660	<u>+100</u>		+110
522		630	568		692	+100		+110
768		910	782		926	+200		+220
822		964	836		980	+200		+220
856		998	870		1014	+200		+220
902		1044	916		1060	+200		+220
968		1110	982		1126	+200		+220
1086		1270	1078		1262	+300		+330
1166		1350	1158		1342	+300		+330
1216		1400	1208		1392	+300		+330
1286		1470	<u>1278</u>		1462	<u>+300</u>		+330
1386		1570	1378		1562	+300		+330
400		508	446		554	+100		+110
428		536	474		582	+100		+110
444		552	<u>490</u>		598	<u>+100</u>		+110
468		576	<u>514</u>		622	<u>+100</u>		+110
500		608	546		654	+100		+110
<u>350</u>		424	<u>350</u>		424	-		-
306		340	306		340	-		-
354		388	<u>354</u>		388	-		-

1. COM price is based on a minimum order of 6 seat units. Use grade B price for smaller orders.
2. A bench seat can be used in place of a link table top at the same premiums listed in note 2. to 3503. Add suffix "B" to product code.
3. An arm can be added between seats on 3403-2 and 3403-3 at an additional \$70. LIST per arm. Add suffix "A" to product code.
4. See note 3. to 3503 for ganging connector.



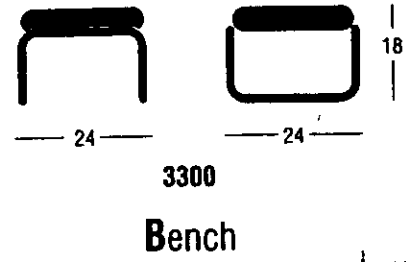
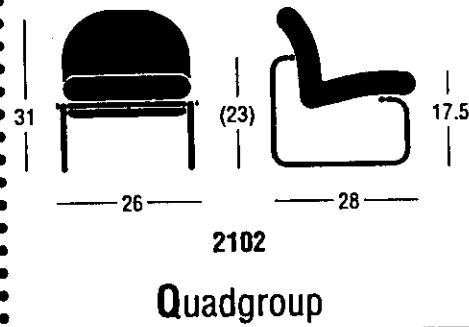

1. COM price is based on a minimum order of 6 seat units. Use grade B price for smaller orders.
2. A bench seat can be used in place of a link table top at the following premiums: COM (1.25 yds) - \$0; Grade A - \$22; Grade B - \$32; Grade C - \$48; Grade D - \$70. Add suffix "B" to product code.
3. A two-piece black plastic ganging connector (model 1.50"-G) is available for \$4. LIST. It is recommended that two connectors be used per join..

1. COM price is based on a minimum order of 6 seat units. Use grade B price for smaller orders.
2. The above pricing represents the premium per unit for the separate seat and back. Add this premium to the price of the regular unit (3403 or 3503) to determine the total unit price. Add suffix "S" to product code.

LOUNGE SEATING



16

FINISH		EPOXY		CHROME		EPOXY		CHROME	
	CHAIR -1	COM	502	580	332	394			
		GRADE A	530	608	352	414			
		GRADE B	546	624	366	428			
		GRADE C	570	648	386	448			
		GRADE D	602	680	412	474			
	SETTEE -2	COM	-	-	542	614			
		GRADE A	-	-	582	654			
		GRADE B	-	-	610	682			
		GRADE C	-	-	650	722			
		GRADE D	-	-	702	774			
	SOFA -3	COM	-	-	742	822			
		GRADE A	-	-	802	882			
		GRADE B	-	-	846	926			
		GRADE C	-	-	904	984			
		GRADE D	-	-	982	1062			
	LINK CHAIR -4	COM	464	522	-	-			
		GRADE A	492	550	-	-			
		GRADE B	508	566	-	-			
		GRADE C	532	590	-	-			
		GRADE D	564	622	-	-			
LINK END TABLE	-5		316	370	-	-			
LINK JOINER TABLE	-6		286	332	-	-			
LINK CORNER TABLE	-7		380	428	-	-			

LOUNGE SEATING TABLES

- The tops are G4 standard laminate, 1.125" thick with self edge.
- For non-standard table top requirements, contact factory for pricing and availability.
- See pages 20-23 for matching occasional tables.

LOUNGE SEATING SPECIFICATIONS

- See page 24 for product specifications, and page 26 for ordering instructions.

1. COM price is based on a minimum order of 6 seat units. Use grade B price for smaller orders.

- Quadgroup is standard WITHOUT ARMS. A single arm frame with upholstered armcap is available at \$60. LIST. Indicate arm locations on layout.
- A bench seat can be used in place of the link table top. See note 2. under model 3503 for details.
- The ends of the tubing are closed with a flat zinc die-cast plug.

1. COM price is based on a minimum order of 6 seat units. Use grade B price for smaller orders.

- A table top can be used in place of a bench seat unit on models -2 and -3 at the following savings: COM - \$0; Grade A - \$22; Grade B - \$32; Grade C - \$48; Grade D - \$70. Indicate locations on layout.
- A two-piece black plastic ganging connector (model 1.50"-G) is available for \$4. LIST. It is recommended that two connectors be used per joint.



**3300
Bench**



**3503
Continuum**

3300 Bench		3503 Continuum	
EPOXY	CHROME	EPOXY	CHROME
386	450	400	492
450	532	542	654
282	344	354	424
-	-	-	-

W x D x H	W x D x H
30 x 30 x 15	28 x 28 x 15
47 x 24 x 15	48 x 28 x 15
24 x 24 x 15	24 x 28 x 15
-	-

<p>1. The table tops are G4 standard laminate, 1.125" thick, with self-edge. Group Four PVC Bullnose edging is available for a premium of \$30. LIST for the -7F Corner Table, \$37. LIST for the -8 Coffee Table and \$25. LIST for the -9 End Table.</p> <p>2. A 0.375" thick clear glass top is available at the prices indicated.</p> <p>3. Shipping: Weight Cubic Feet -7F Corner Table: 50 lbs. 9.0 cu.ft. -8 Coffee Table: 55 lbs. 12.0 cu.ft. -9 End Table: 35 lbs. 6.0 cu.ft.</p>	<p>1. The table tops are G4 standard laminate, 1.125" thick, with self-edge. Group Four PVC Bullnose edging is available for a premium of \$30. LIST for the -7F Corner Table, \$37. LIST for the -8 Coffee Table and \$25. LIST for the -9 End Table.</p> <p>2. A 0.375" thick clear glass top is available at the prices indicated.</p> <p>3. Shipping: Weight Cubic Feet -7F Corner Table: 50 lbs. 9.0 cu.ft. -8 Coffee Table: 55 lbs. 12.0 cu.ft. -9 End Table: 35 lbs. 6.0 cu.ft.</p>
---	---

OCCASIONAL TABLES

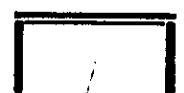
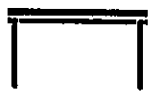

2102

Quadgroup

2503

Brava

20

FINISH	2102 Quadgroup		2503 Brava	
	EPOXY	CHROME	EPOXY	CHROME
CORNER TABLE -7F	-	-	-	-
COFFEE TABLE -8	572	662	622	678
END TABLE -9	336	392	420	456
CIRCULAR TABLE -10	-	-	-	-
DIMENSIONS (inches)	W x D x H		W x D x H	
CORNER TABLE -7F	-		-	
COFFEE TABLE -8	48 x 26 x 15		42 x 26 x 16	
END TABLE -9	24 x 26 x 15		24 x 26 x 16	
CIRCULAR TABLE -10	-		-	

- The table tops are G4 standard laminate, 1.125" thick, with self-edge. Group Four PVC Bullnose edging is available for a premium of \$37. LIST for the -8 Coffee Table and \$25. LIST for the -9 End Table.
- A 0.375" thick clear glass top is available at the prices indicated.
- Shipping:

	Weight	Cubic Feet
-8 Coffee Table:	55 lbs.	12.0 cu.ft.
-9 End Table:	35 lbs.	6.0 cu.ft.

- The table tops are G4 standard laminate, 1.125" thick, with self-edge. Group Four PVC Bullnose edging is available for a premium of \$37. LIST for the -8 Coffee Table and \$25. LIST for the -9 End Table.
- A 0.375" thick clear glass top is available at the prices indicated.
- Shipping:

	Weight	Cubic Feet
-8 Coffee Table:	55 lbs.	12.0 cu.ft.
-9 End Table:	35 lbs.	6.0 cu.ft.

LEE CO. HENDRY ST. 1ST FLOOR: FIRE MARSHALL
F2214FIRE.SP4

Item	Cat	Qty	Part Number	Part Description	List \$	Sell \$	Ext Sell \$	Sell- %
1	HVG	1	ZCFLA	@Common File Top,Laminate,Sq. PVC Edge (A) @One Unit Deep @20in Deep @Two Units Wide @36in Wide @36in Wide @No Overhang(Depth) @Standard HMI Laminates @Kale Skipped Option	\$ 288.00	\$ 97.46	\$ 97.46	66.160
2	MER	3	26-3620-2N	+File,FS Lat Std Pull,2 Dwr +textured steel +inner tone light +1 1/4"-high painted metal top with square... +keyed differently, black +1 1/2"-high base +counterweight (recommended) +side-to-side filing rail	\$ 755.00	\$ 255.49	\$ 766.47	66.160
3	MER	4	46-3615-OB-68	+Bookcase Four Adjust Shelves 68-3/8H 36W 15D +Textured Steel +inner tone Light non-metallic +Standard Metal Top 1-1/4 +With Four Shelves +1-1/2in Base	\$ 595.00	\$ 222.35	\$ 889.40	62.630
4	MER	1	46-4220-29	+Storage Case Std Pull 42W 20D 29H +Textured Steel +inner tone Light non-metallic +One Shelf +Black - Keyed Differently +Square Edge Metal Top 1-1/4 +With Doors +1-1/2in Base	\$ 627.00	\$ 234.31	\$ 234.31	62.630
5	MER	2	46-4220-69	+Storage Case Std Pull 42W 20D 68-3/8H +Textured Steel +inner tone Light non-metallic +Four Shelves +Black - Keyed Differently +Square Edge Metal Top 1-1/4 +With Doors +1-1/2in Base	\$ 1,006.00	\$ 375.94	\$ 751.88	62.630
6	HAO	1	A2391.L	+Corner Wedge 16W +kale	\$ 88.00	\$ 24.02	\$ 24.02	72.700
7	HST	2	AD10PB	+Side Chair,Stk,Aside,Nonuphol Outer Back +metal arms +glide +medium tone +crepe-Pr Cat 2 +crepe raisin	\$ 285.00	\$ 136.80	\$ 273.60	52.000
8	HST	1	AE122AWB	+Chair,Aeron Wk,Two-Stage Pneu.,Tit Lim,Adj Arms +adjustable PostureFit™ support +graphite +2 1/2" hard caster, black yoke, carpet +black +pellicle@ classic-Pr Cat 1 +pellicle@ classic jade	\$ 1,165.00	\$ 470.66	\$ 470.66	59.600
9	HEI	1	E1110.3818N	+Frame,Npwr No Access 38H 18W +inner tone light +inner tone light	\$ 276.00	\$ 78.11	\$ 78.11	71.700
10	HEI	1	E1110.3824C	+Frame,Npwr Access Holes 38H 24W +inner tone light +inner tone light	\$ 292.00	\$ 82.64	\$ 82.64	71.700
11	HEI	4	E1110.3824E	+Frame,Pwr 4-Circ 38H 24W +inner tone light +inner tone light	\$ 415.00	\$ 117.45	\$ 469.80	71.700

LEE CO. HENDRY ST. 1ST FLOOR: FIRE MARSHALL
F2214FIRE.SP4

Item	Cat	Qty	Part Number	Part Description	List \$	Sell \$	Ext Sell \$	Sell-%
12	HEI	2	E1110.3830C	+Frame,Npwr Access Holes 38H 30W	\$ 323.00	\$ 91.41	\$ 182.82	71.700
			HF	+inner tone light				
			HF	+inner tone light				
13	HEI	5	E1110.3830E	+Frame,Pwr 4-Circ 38H 30W	\$ 446.00	\$ 126.22	\$ 631.10	71.700
			HF	+inner tone light				
			HF	+inner tone light				
14	HEI	5	E1110.3842E	+Frame,Pwr 4-Circ 38H 42W	\$ 508.00	\$ 143.76	\$ 718.80	71.700
			HF	+inner tone light				
			HF	+inner tone light				
15	HEI	2	E1110.7024C	+Frame,Npwr Access Holes 70H 24W	\$ 376.00	\$ 106.41	\$ 212.82	71.700
			HF	+inner tone light				
			HF	+inner tone light				
16	HEI	8	E1110.7024E	+Frame,Pwr 4-Circ 70H 24W	\$ 499.00	\$ 141.22	\$ 1,129.76	71.700
			HF	+inner tone light				
			HF	+inner tone light				
17	HEI	9	E1110.7030C	+Frame,Npwr Access Holes 70H 30W	\$ 407.00	\$ 115.18	\$ 1,036.62	71.700
			HF	+inner tone light				
			HF	+inner tone light				
18	HEI	21	E1110.7030E	+Frame,Pwr 4-Circ 70H 30W	\$ 530.00	\$ 149.99	\$ 3,149.79	71.700
			HF	+inner tone light				
			HF	+inner tone light				
19	HEI	1	E1110.7036E	+Frame,Pwr 4-Circ 70H 36W	\$ 561.00	\$ 158.76	\$ 158.76	71.700
			HF	+inner tone light				
			HF	+inner tone light				
20	HEI	6	E1110.7042E	+Frame,Pwr 4-Circ 70H 42W	\$ 592.00	\$ 167.54	\$ 1,005.24	71.700
			HF	+inner tone light				
			HF	+inner tone light				
21	HEI	2	E1110.7048E	+Frame,Pwr 4-Circ 70H 48W	\$ 622.00	\$ 176.03	\$ 352.06	71.700
			HF	+inner tone light				
			HF	+inner tone light				
22	HEI	1	E1210.38	+Wall Start 38H	\$ 67.00	\$ 18.96	\$ 18.96	71.700
			HF	+inner tone light				
23	HEI	1	E1210.70	+Wall Start 70H	\$ 78.00	\$ 22.07	\$ 22.07	71.700
			HF	+inner tone light				
24	HEI	2	E1220.38SRE	+Conn,2-Way 90 Vinyl,Pwr 38H	\$ 198.00	\$ 56.03	\$ 112.06	71.700
			HF	+inner tone light				
			HF	+inner tone light				
			HF	+inner tone light				
25	HEI	16	E1220.70SRE	+Conn,2-Way 90 Vinyl,Pwr 70H	\$ 243.00	\$ 68.77	\$ 1,100.32	71.700
			HF	+inner tone light				
			HF	+inner tone light				
			HF	+inner tone light				
26	HEI	4	E1230.70SE	+Conn,3-Way 90 Vinyl,Pwr 70H	\$ 320.00	\$ 90.56	\$ 362.24	71.700
			HF	+inner tone light				
			HF	+inner tone light				
			HF	+inner tone light				
27	HEI	5	E1250.38S	+Fin End,Std 38H	\$ 49.00	\$ 13.87	\$ 69.35	71.700
			HF	+inner tone light				
28	HEI	11	E1250.70S	+Fin End,Std 70H	\$ 59.00	\$ 16.70	\$ 183.70	71.700
			HF	+inner tone light				
29	HEI	10	E1251.32S	+Ch of Ht Fin End Std 32H	\$ 46.00	\$ 13.02	\$ 130.20	71.700
			HF	+inner tone light				
30	HEI	7	E1322.06E	+Power Entry,Ext. Dir Con 4-Circ,6Ft L	\$ 120.00	\$ 33.96	\$ 237.72	71.700
31	HEI	6	E1341.3E	+Power Jumper,4-Circ,4th 8H Tile Above Base	\$ 75.00	\$ 21.23	\$ 127.38	71.700

LEE CO. HENDRY ST. 1ST FLOOR: FIRE MARSHALL
F2214FIRE.SP4

Item	Cat	Qty	Part Number	Part Description	List \$	Sell \$	Ext Sell \$	Sell-%
32	HEI	5	E1357.24E	+Harness,Elec,4-Circ,Pwr 24W Frame	\$ 141.00	\$ 39.90	\$ 199.50	71.700
33	HEI	8	E1357.30E	+Harness,Elec,4-Circ,Pwr 30W Frame	\$ 146.00	\$ 41.32	\$ 330.56	71.700
34	HEI	3	E1357.42E	+Harness,Elec,4-Circ,Pwr 42W Frame	\$ 153.00	\$ 43.30	\$ 129.90	71.700
35	HEI	1	E1357.48E	+Harness,Elec,4-Circ,Pwr 48W Frame	\$ 158.00	\$ 44.71	\$ 44.71	71.700
36	HEI	10	E1411.1630T	+Tile,Glazed Window Top 16H 30W	\$ 92.00	\$ 26.04	\$ 260.40	71.700
			HF	+inner tone light				
			TR	+clear				
37	HEI	4	E1420.1618P	+Tile,Face Painted 16H 18W	\$ 38.00	\$ 10.75	\$ 43.00	71.700
			HF	+inner tone light				
38	HEI	28	E1420.1624F	+Tile,Face Fabric 16H 24W	\$ 59.00	\$ 16.70	\$ 467.60	71.700
			1Z	+penumbra-Pr Cat 1				
			02	+penumbra phoebe				
39	HEI	53	E1420.1624P	+Tile,Face Painted 16H 24W	\$ 41.00	\$ 11.60	\$ 614.80	71.700
			HF	+inner tone light				
40	HEI	97	E1420.1630F	+Tile,Face Fabric 16H 30W	\$ 64.00	\$ 18.11	\$ 1,756.67	71.700
			1Z	+penumbra-Pr Cat 1				
			02	+penumbra phoebe				
41	HEI	110	E1420.1630P	+Tile,Face Painted 16H 30W	\$ 45.00	\$ 12.74	\$ 1,401.40	71.700
			HF	+inner tone light				
42	HEI	2	E1420.1636F	+Tile,Face Fabric 16H 36W	\$ 71.00	\$ 20.09	\$ 40.18	71.700
			1Z	+penumbra-Pr Cat 1				
			02	+penumbra phoebe				
43	HEI	3	E1420.1636P	+Tile,Face Painted 16H 36W	\$ 50.00	\$ 14.15	\$ 42.45	71.700
			HF	+inner tone light				
44	HEI	9	E1420.1642F	+Tile,Face Fabric 16H 42W	\$ 77.00	\$ 21.79	\$ 196.11	71.700
			1Z	+penumbra-Pr Cat 1				
			02	+penumbra phoebe				
45	HEI	37	E1420.1642P	+Tile,Face Painted 16H 42W	\$ 56.00	\$ 15.85	\$ 586.45	71.700
			HF	+inner tone light				
46	HEI	1	E1420.1648F	+Tile,Face Fabric 16H 48W	\$ 84.00	\$ 23.77	\$ 23.77	71.700
			1Z	+penumbra-Pr Cat 1				
			02	+penumbra phoebe				
47	HEI	9	E1420.1648P	+Tile,Face Painted 16H 48W	\$ 61.00	\$ 17.26	\$ 155.34	71.700
			HF	+inner tone light				
48	HEI	11	E1422.1630	+Tile,Tackable 16H 30W	\$ 110.00	\$ 31.13	\$ 342.43	71.700
			64	+flannel-Pr Cat 4				
			24	+flannel grape				
49	HEI	1	E1422.1642	+Tile,Tackable 16H 42W	\$ 135.00	\$ 38.21	\$ 38.21	71.700
			64	+flannel-Pr Cat 4				
			24	+flannel grape				
50	HEI	1	E1422.1648	+Tile,Tackable 16H 48W	\$ 144.00	\$ 40.75	\$ 40.75	71.700
			64	+flannel-Pr Cat 4				
			24	+flannel grape				
51	HEI	10	E1425.1624	+Tile,Rail 16H 24W	\$ 126.00	\$ 35.66	\$ 356.60	71.700
			HF	+inner tone light				
52	HEI	3	E1425.1630	+Tile,Rail 16H 30W	\$ 141.00	\$ 39.90	\$ 119.70	71.700
			HF	+inner tone light				
53	HEI	3	E1425.1642	+Tile,Rail 16H 42W	\$ 169.00	\$ 47.83	\$ 143.49	71.700
			HF	+inner tone light				
54	HEI	1	E1425.1648	+Tile,Rail 16H 48W	\$ 183.00	\$ 51.79	\$ 51.79	71.700
			HF	+inner tone light				

LEE CO. HENDRY ST. 1ST FLOOR: FIRE MARSHALL
F2214FIRE.SP4

Item	Cat	Qty	Part Number	Part Description	List \$	Sell \$	Ext Sell \$	Sell- %
55	HEI	6	E1432.1624P	+Tile,Cable Access Pkg Painted 16H 24W	\$ 95.00	\$ 26.89	\$ 161.34	71.700
			HF	+inner tone light				
			HF	+inner tone light				
			HF	+inner tone light				
56	HEI	10	E1432.1630P	+Tile,Cable Access Pkg Painted 16H 30W	\$ 111.00	\$ 31.41	\$ 314.10	71.700
			HF	+inner tone light				
			HF	+inner tone light				
			HF	+inner tone light				
57	HEI	3	E1432.1642P	+Tile,Cable Access Pkg Painted 16H 42W	\$ 131.00	\$ 37.07	\$ 111.21	71.700
			HF	+inner tone light				
			HF	+inner tone light				
			HF	+inner tone light				
58	HEI	1	E1432.1648P	+Tile,Cable Access Pkg Painted 16H 48W	\$ 141.00	\$ 39.90	\$ 39.90	71.700
			HF	+inner tone light				
			HF	+inner tone light				
			HF	+inner tone light				
59	HEI	1	E2170.3072L	+Peninsula,Sq-Edge Rect,Column 30D 72W	\$ 959.00	\$ 271.40	\$ 271.40	71.700
			8X	+kale				
			HF	+inner tone light				
			SM	+on module				
60	HEI	2	E2210.2442L	+Work Surf,Sq-Edge Rect Lam 24D 42W	\$ 324.00	\$ 91.69	\$ 183.38	71.700
			8X	+kale				
			HF	+inner tone light				
			SM	+on module				
61	HEI	1	E2210.2472L	+Work Surf,Sq-Edge Rect Lam 24D 72W	\$ 540.00	\$ 152.82	\$ 152.82	71.700
			8X	+kale				
			HF	+inner tone light				
			SM	+on module				
62	HEI	2	E2210.2484L	+Work Surf,Sq-Edge Rect Lam 24D 84W	\$ 628.00	\$ 177.72	\$ 355.44	71.700
			8X	+kale				
			HF	+inner tone light				
			SM	+on module				
63	HEI	1	E2210.3024L	+Work Surf,Sq-Edge Rect Lam 30D 24W	\$ 270.00	\$ 76.41	\$ 76.41	71.700
			8X	+kale				
			HF	+inner tone light				
			SM	+on module				
64	HEI	5	E2210.3042L	+Work Surf,Sq-Edge Rect Lam 30D 42W	\$ 405.00	\$ 114.62	\$ 573.10	71.700
			8X	+kale				
			HF	+inner tone light				
			SM	+on module				
65	HEI	1	E2210.3048L	+Work Surf,Sq-Edge Rect Lam 30D 48W	\$ 446.00	\$ 126.22	\$ 126.22	71.700
			8X	+kale				
			HF	+inner tone light				
			SM	+on module				
66	HEI	1	E2210.3072L	+Work Surf,Sq-Edge Rect Lam 30D 72W	\$ 696.00	\$ 196.97	\$ 196.97	71.700
			8X	+kale				
			HF	+inner tone light				
			SM	+on module				
67	HEI	8	E2210.3084L	+Work Surf,Sq-Edge Rect Lam 30D 84W	\$ 783.00	\$ 221.59	\$ 1,772.72	71.700
			8X	+kale				
			HF	+inner tone light				
			SM	+on module				
68	HEI	1	E2210.3096L	+Work Surf,Sq-Edge Rect Lam 30D 96W	\$ 864.00	\$ 244.51	\$ 244.51	71.700
			8X	+kale				
			HF	+inner tone light				
			SM	+on module				
69	HEI	1	E2232.3042L	+Work Surf,Sq-Edge Cor Lam 30D 42W	\$ 600.00	\$ 169.80	\$ 169.80	71.700
			8X	+kale				
			HF	+inner tone light				
			SM	+on module				

LEE CO. HENDRY ST. 1ST FLOOR: FIRE MARSHALL
F2214FIRE.SP4

Item	Cat	Qty	Part Number	Part Description	List \$	Sell \$	Ext Sell \$	Sell- %
70	HEI	2	E2280.24L	+Support Panel,Wk Surf Lam,End 24D HF HF HF +inner tone light +inner tone light +inner tone light	\$ 304.00	\$ 86.03	\$ 172.06	71.700
71	HEI	1	E2281.L	+Support Panel,Wk Surf Lam,Mid-Run HF HF HF +inner tone light +inner tone light +inner tone light	\$ 304.00	\$ 86.03	\$ 86.03	71.700
72	HEI	1	E2812.24LN	+Trans Surf,Sq-Edge Rect End Lam,No Cutout 24W 8X +kale	\$ 177.00	\$ 50.09	\$ 50.09	71.700
73	HEI	1	E2812.42LN	+Trans Surf,Sq-Edge Rect End Lam,No Cutout 42W 8X +kale	\$ 206.00	\$ 58.30	\$ 58.30	71.700
74	HEI	1	E3212.30F	+Flip Dr Unit,B-Style Fabric W/Lock 13D 30W KD +keyed differently HF +inner tone light SM +on module 32 +iota™-Pr Cat 4 12 +iota™ marsh ice	\$ 406.00	\$ 114.90	\$ 114.90	71.700
75	HEI	1	E3212.42F	+Flip Dr Unit,B-Style Fabric W/Lock 13D 42W KD +keyed differently HF +inner tone light SM +on module 32 +iota™-Pr Cat 4 12 +iota™ marsh ice	\$ 463.00	\$ 131.03	\$ 131.03	71.700
76	HEI	1	E3212.48F	+Flip Dr Unit,B-Style Fabric W/Lock 13D 48W KD +keyed differently HF +inner tone light SM +on module 32 +iota™-Pr Cat 4 12 +iota™ marsh ice	\$ 486.00	\$ 137.54	\$ 137.54	71.700
77	HEI	12	E3230.24	+Shelf,B-Style Open 7-1/2H 24W HF +inner tone light	\$ 97.00	\$ 27.45	\$ 329.40	71.700
78	HEI	20	E3230.30	+Shelf,B-Style Open 7-1/2H 30W HF +inner tone light	\$ 102.00	\$ 28.87	\$ 577.40	71.700
79	HEI	1	E3230.36	+Shelf,B-Style Open 7-1/2H 36W HF +inner tone light	\$ 109.00	\$ 30.85	\$ 30.85	71.700
80	HEI	3	E3230.42	+Shelf,B-Style Open 7-1/2H 42W HF +inner tone light	\$ 117.00	\$ 33.11	\$ 99.33	71.700
81	HEI	1	E3230.48	+Shelf,B-Style Open 7-1/2H 48W HF +inner tone light	\$ 121.00	\$ 34.24	\$ 34.24	71.700
82	HST	12	EE122AB	+Chair,Ergon 3 Pneu,Adj Arms,Knee Tilt,Sz B +not adjustable N4 +medium tone MT +2" hd dbl wl caster, carpet BC +nonupholstered U6 +medium tone MT +crepe-Pr Cat 2 92 +crepe raisin 12	\$ 906.00	\$ 292.91	\$ 3,514.92	67.670
83	HMH	2	ET114L	+Table,Square Contract Base Lam Top 28.5H 42W 8X +kale Skipped Option	\$ 540.00	\$ 147.42	\$ 294.84	72.700
84	HMH	1	ET151L	+Table,Oval Seg Base Vin Edge/Lam Top 28.5H 42D 72W 8X +kale Skipped Option	\$ 1,675.00	\$ 457.28	\$ 457.28	72.700

LEE CO. HENDRY ST. 1ST FLOOR: FIRE MARSHALL
F2214FIRE.SP4

Item	Cat	Qty	Part Number	Part Description	List \$	Sell \$	Ext Sell \$	Sell- %
85	MER	13	F16-1822-BBF	+Freestanding Ped Std Pull 18W 22D 26-1/4H (BBF) +Textured Steel +inner tone Light non-metallic +Square Metal Top 1-1/4 +Black - Keyed Differently +Base 1-1/2 +Counterweight(recommended) +Std. Compressor	\$ 630.00	\$ 241.79	\$ 3,143.27	61.620
			TS					
			HF					
			T2					
			KD					
			B2					
			CB					
			C					
86	MA4	8	7868C	Mayline Self-Contained Steel C Plan Files, Five-Drawer File for 30" x 42" sheets - Overall Unit size: 46-3/4"W x 15-3/8"H x 35-3/8"D -NEED TO SELECT FINISH	\$ 1,177.00	\$ 439.84	\$ 3,518.72	62.630
87	MA4	4	7868W	Mayline Flush Base for 30" x 42" Size File, 4"H -NEED TO SELECT FINISH	\$ 196.00	\$ 73.25	\$ 293.00	62.630
88	HVG	2	ZCELA	@Exact Size File Top,Sq-Edge Vinyl Frt,Lam Top @Depth: 30.01in - 54.00in 35-3/8" D @Width: 84.01in - 96.00in 93.5" W @Standard HMI Laminates @Kale Skipped Option TAG: FOR MAYLINE FLAT FILES	\$ 864.00	\$ 292.38	\$ 584.76	66.160
			D02					
			W07					
			EZ					
			8X					
			...					
89	HMU	7	G5010.	+Drw,Pencil 21W 16D	\$ 42.00	\$ 11.47	\$ 80.29	72.700
			HF	+inner tone light				
90	HMU	10	G6120.24MEN	+Task Light,E.E. Electronic Ballast/No Dimmer 24W	\$ 210.00	\$ 57.33	\$ 573.30	72.700
			HF	+inner tone light				
91	HMU	21	G6120.30MEN	+Task Light,E.E. Electronic Ballast/No Dimmer 30W	\$ 218.00	\$ 59.51	\$ 1,249.71	72.700
			HF	+inner tone light				
92	HMU	1	G6120.36MEN	+Task Light,E.E. Electronic Ballast/No Dimmer 36W	\$ 224.00	\$ 61.15	\$ 61.15	72.700
			HF	+inner tone light				
93	HMU	4	G6120.42MEN	+Task Light,E.E. Electronic Ballast/No Dimmer 42W	\$ 234.00	\$ 63.88	\$ 255.52	72.700
			HF	+inner tone light				
94	HMU	2	G6120.48MEN	+Task Light,E.E. Electronic Ballast/No Dimmer 48W	\$ 239.00	\$ 65.25	\$ 130.50	72.700
			HF	+inner tone light				
95	HMU	3	G7130.	+Diag Tray	\$ 51.00	\$ 13.92	\$ 41.76	72.700
			HF	+inner tone light				
				TAG: FRONT MAIL AREA				
96	HMU	5	G7715.04K	+Keybd Tray,Fully Adj,Std-Length Arm,Knob Adj	\$ 356.00	\$ 97.19	\$ 485.95	72.700
			HF	+inner tone light				
97	HMU	2	G7715.08K	+Keybd Tray,Fully Adj,Knob Adj 21In Trk	\$ 382.00	\$ 104.29	\$ 208.58	72.700
			HF	+inner tone light				
98	HMU	7	G7742.	+Mouse Tray,Wk Surf Att,Adj/Storable	\$ 206.00	\$ 56.24	\$ 393.68	72.700
99	HST	8	WC410N	+Chair,Caper® Multipurpose Stacking,Molded Seat,No Arms +metallic silver +evergreen +soft wheel caster, carpet or hard floors	\$ 215.00	\$ 84.69	\$ 677.52	60.610
			MS					
			EM					
			U5					
100	HCE	1	ZERLA	@Vary Easy Etho Sq-Edge Vinyl Frt Rect Wk Surf,w/ wire/grmt,Lam Top @24D @24D 51.5W @W/Cbl Mgmt Trgh-No Gap (Std Etho Gap) @Kale Skipped Option @Inner Tone Light Supt @On Module	\$ 375.00	\$ 106.13	\$ 106.13	71.700
			24					
			52					
			9A					
			8X					
			...					
			HF					
			SM					
101	HMU	14	G7110.10	+Paper Tray 10W	\$ 32.00	\$ 8.74	\$ 122.36	72.700
			HF	+inner tone light				

LEE CO. HENDRY ST. 1ST FLOOR: FIRE MARSHALL
 F2214FIRE.SP4

Item	Cat	Qty	Part Number	Part Description	List \$	Sell \$	Ext Sell \$	Sell- %
102	HMU	7	G7130. HF	+Diag Tray +inner tone light	\$ 51.00	\$ 13.92	\$ 97.44	72.700
103	HMU	7	G7120.8 HF	+Vert Tray 8W +inner tone light	\$ 46.00	\$ 12.56	\$ 87.92	72.700
104	HMU	7	G7310.15 HF	+Mini-Shelf 15W +inner tone light	\$ 46.00	\$ 12.56	\$ 87.92	72.700
105	GR3	3	3503S-1-E G4-03 CRE-55	GROUP 4 CONTINUUM SERIES CHAIR (SPLIT SEAT & BACK) EPOXY FRAME ANTIQUE WHITE EPOXY FRAME OLYMPIAD VINYLs CRETE CURRANT	\$ 612.00	\$ 287.64	\$ 862.92	53.000
106	GR3	2	3503S-4-E G4-03 CRE-55	GROUP 4 CONTINUUM SERIES LINK CHAIR (SPLIT SEAT & BACK) EPOXY FR. ANTIQUE WHITE EPOXY FRAME OLYMPIAD VINYLs CRETE CURRANT	\$ 590.00	\$ 277.30	\$ 554.60	53.000
107	GR3	3	3503-5-E G4-03 4634 G4-03	GROUP 4 CONTINUUM SERIES LINK END TABLE EPOXY FRAME, PVC EDGE ANTIQUE WHITE EPOXY FRAME STORM NEBULA ANTIQUE WHITE PVC EDGE	\$ 350.00	\$ 164.50	\$ 493.50	53.000
108	GU1	23	SUBC-INSTALLATION	DELIVERY & INSTALLATION OF CHAIRS PER STATE CONTRACT GUIDELINES	\$ 15.00	\$ 15.00	\$ 345.00	0.000
109	GU1	3	SUBC-INSTALLATION	DELIVERY & INSTALLATION OF TABLES PER STATE CONTRACT GUIDELINES	\$ 100.00	\$ 100.00	\$ 300.00	0.000
110	GU1	1	SUBC-INSTALLATION	DELIVERY & INSTALLATION	\$ 9,075.01	\$ 9,075.00	\$ 9,075.00	0.000
111	651	1	DESIGN	DESIGN SERVICES COVERED UNDER SEPARATE AGREEMENT SPEC ENTERED 4/29/03	\$ 0.00	\$ 0.00	\$ 0.00	0.000
Grand Total							\$ 57,133.96	65.039

LEE CO. HENDRY ST. 1ST FLOOR: CITY
F2214CITY.SP4

Item	Cat	Qty	Part Number	Part Description	List \$	Sell \$	Ext Sell \$	Sell-%
1	MER	9	26-3020-2N	+File,FS Lat Std Pull,2 Dwr +textured steel +inner tone light +1 1/4"-high painted metal top with squared edge +keyed differently, black +1 1/2"-high base +counterweight (recommended) +side-to-side filing rail	\$ 690.00	\$ 233.50	\$ 2,101.50	66.160
2	MER	7	26-3020-4E	+File,FS Lat Std Pull,4 Dwr +textured steel +inner tone light +1 1/4"-high painted metal top with squared edge +keyed differently, black +1 1/2"-high base +counterweight (recommended) +side-to-side filing rail	\$ 1,150.00	\$ 389.16	\$ 2,724.12	66.160
3	MER	1	26-3620-3E	+File,FS Lat Std Pull,3 Dwr +textured steel +inner tone light +1 1/4"-high painted metal top with squared edge +keyed differently, black +1 1/2"-high base +counterweight (recommended) +side-to-side filing rail	\$ 1,006.00	\$ 340.43	\$ 340.43	66.160
4	MER	33	26-3620-4E	+File,FS Lat Std Pull,4 Dwr +textured steel +inner tone light +1 1/4"-high painted metal top with squared edge +keyed differently, black +1 1/2"-high base +counterweight (recommended) +side-to-side filing rail	\$ 1,257.00	\$ 425.37	\$ 14,037.21	66.160
5	MER	6	46-3020-26	+Storage Case Std Pull 30W 20D 26-1/4H +Textured Steel +inner tone Light non-metallic +One Shelf +Black - Keyed Differently +Square Edge Metal Top 1-1/4 +With Doors +1-1/2in Base TAG: FRONT COUNTER	\$ 459.00	\$ 171.53	\$ 1,029.18	62.630
6	MER	2	46-3020-29	+Storage Case Std Pull 30W 20D 29H +Textured Steel +inner tone Light non-metallic +One Shelf +Black - Keyed Differently +Square Edge Metal Top 1-1/4 +With Doors +1-1/2in Base TAG: COPIER/PRINTER	\$ 485.00	\$ 181.24	\$ 362.48	62.630
7	MER	4	46-3615-OB-29	+Bookcase One Adjust Shelf 29H 36W 15D +Textured Steel +inner tone Light non-metallic +Standard Metal Top 1-1/4 +With One Shelf +1-1/2in Base TAG: ARCHIVE & COPY AREA	\$ 513.00	\$ 191.71	\$ 766.84	62.630
8	MER	2	46-3615-OB-42	+Bookcase Two Adjust Shelves 42-1/8H 36W 15D +Textured Steel +inner tone Light non-metallic +Standard Metal Top 1-1/4 +With Two Shelves +1-1/2in Base TAG: FRONT AREA	\$ 542.00	\$ 202.55	\$ 405.10	62.630
9	MER	6	46-3615-OB-68	+Bookcase Four Adjust Shelves 68-3/8H 36W 15D +Textured Steel +inner tone Light non-metallic +Standard Metal Top 1-1/4 +With Four Shelves +1-1/2in Base TAG: REFERENCE	\$ 595.00	\$ 222.35	\$ 1,334.10	62.630

LEE CO. HENDRY ST. 1ST FLOOR: CITY
F2214CITY.SP4

Item	Cat	Qty	Part Number	Part Description	List \$	Sell \$	Ext Sell \$	Sell- %
10	MEC	1	5-36-TLM	+Task Light,36W	\$ 150.00	\$ 63.63	\$ 63.63	57.580
11	MEC	8	5-48-TLM	+Task Light,48W	\$ 160.00	\$ 67.87	\$ 542.96	57.580
12	MEC	4	5-60-TLE	+Task Light,60W	\$ 200.00	\$ 84.84	\$ 339.36	57.580
13	MEC	1	5F-4839-ODR	+Flipper Door Unit w/Tool Rail,48W,Fabric Doors	\$ 1,277.00	\$ 541.70	\$ 541.70	57.580
			64	+Flannel Fabrics, Category-4				
			24	+Flannel-Grape				
			TS	+Textured Steel				
			HF	+inner tone Light non-metallic				
			1Z	+Penumbra Fabrics, Category-1				
			02	+penumbra phoebe				
			KD	+Black - Keyed Differently				
14	MEC	8	5F-6039-ODR	+Flipper Door Unit w/Tool Rail,60W,Fabric Doors	\$ 1,397.00	\$ 592.61	\$ 4,740.88	57.580
			64	+Flannel Fabrics, Category-4				
			24	+Flannel-Grape				
			TS	+Textured Steel				
			HF	+inner tone Light non-metallic				
			1Z	+Penumbra Fabrics, Category-1				
			02	+penumbra phoebe				
			KD	+Black - Keyed Differently				
15	MEC	4	5F-7239-ODR	+Flipper Door Unit w/Tool Rail,72W,Fabric Doors	\$ 1,489.00	\$ 631.63	\$ 2,526.52	57.580
			64	+Flannel Fabrics, Category-4				
			24	+Flannel-Grape				
			TS	+Textured Steel				
			HF	+inner tone Light non-metallic				
			1Z	+Penumbra Fabrics, Category-1				
			02	+penumbra phoebe				
			KD	+Black - Keyed Differently				
16	MEC	5	5F0-3030C-OLD	+Corner Return Shell,Full BPnl,30Wx30D,End Panel(r)	\$ 582.00	\$ 246.88	\$ 1,234.40	57.580
			TS	+Textured Steel				
			HF	+inner tone Light non-metallic				
			TL	+Laminate Top/PVC Edge				
			8X	+Kale				
			HF	+inner tone light				
			C	+Single Grommet - Center Skipped Option				
17	MEC	2	5F0-3624-D	+Bridge,Full BPnl,36Wx24D	\$ 320.00	\$ 135.74	\$ 271.48	57.580
			TS	+Textured Steel				
			HF	+inner tone Light non-metallic				
			TL	+Laminate Top/PVC Edge				
			8X	+Kale				
			HF	+inner tone light				
			C	+Single Grommet - Center Skipped Option				
18	MEC	2	5F0-3624-LOD	+Return Shell,Full BPnl,36Wx24D,L End Panel(l)	\$ 529.00	\$ 224.40	\$ 448.80	57.580
			TS	+Textured Steel				
			HF	+inner tone Light non-metallic				
			TL	+Laminate Top/PVC Edge				
			8X	+Kale				
			HF	+inner tone light				
			C	+Single Grommet - Center Skipped Option				
19	MEC	1	5F0-4224-D	+Bridge,Full BPnl,42Wx24D	\$ 343.00	\$ 145.50	\$ 145.50	57.580
			TS	+Textured Steel				
			HF	+inner tone Light non-metallic				
			TL	+Laminate Top/PVC Edge				
			8X	+Kale				
			HF	+inner tone light				
			C	+Single Grommet - Center Skipped Option				
20	MEC	5	5F0-424224-SS	+Comer Desk,Full BPnl,42x42x24,SS	\$ 771.00	\$ 327.06	\$ 1,635.30	57.580
			TS	+Textured Steel				
			HF	+inner tone Light non-metallic				
			TL	+Laminate Top/PVC Edge				
			8X	+Kale				
			HF	+inner tone light				
			C	+Single Grommet - Center Skipped Option				

LEE CO. HENDRY ST. 1ST FLOOR: CITY
F2214CITY.SP4

Item	Cat	Qty	Part Number	Part Description	List \$	Sell \$	Ext Sell \$	Sell-%
21	MEC	1	5F0-4830-LL	+Desk Shell,Full Back Panel,48Wx30D,LL +Textured Steel +inner tone Light non-metallic +Laminate Top/PVC Edge +Kale +inner tone light +Single Grommet - Center Skipped Option	\$ 800.00	\$ 339.36	\$ 339.36	57.580
			TS HF TL 8X HF C					
22	MEC	8	5F0-6030-LL	+Desk Shell,Full Back Panel,60Wx30D,LL +Textured Steel +inner tone Light non-metallic +Laminate Top/PVC Edge +Kale +inner tone light +Single Grommet - Center Skipped Option	\$ 874.00	\$ 370.75	\$ 2,966.00	57.580
			TS HF TL 8X HF C					
23	MEC	5	5F0-7230-LL	+Desk Shell,Full Back Panel,72Wx30D,LL +Textured Steel +inner tone Light non-metallic +Laminate Top/PVC Edge +Kale +inner tone light +Single Grommet - Center +Inner Tone Light	\$ 960.00	\$ 407.23	\$ 2,036.15	57.580
			TS HF TL 8X HF C HF					
24	MEC	1	5P0-4824-D	+Bridge,Open BPl,48Wx24D +Textured Steel +inner tone Light non-metallic +Laminate Top/PVC Edge +Kale +inner tone light +Single Grommet - Center +Inner Tone Light	\$ 377.00	\$ 159.92	\$ 159.92	57.580
			TS HF TL 8X HF C HF					
25	MEC	6	72-2016-SP	+Pencil Drawer, Metal, 24D to 36D wksfc +inner tone Light non-metallic	\$ 90.00	\$ 38.18	\$ 229.08	57.580
			HF					
26	HAO	15	A2391.L	+Corner Wedge 16W +kale	\$ 88.00	\$ 24.02	\$ 360.30	72.700
			8X					
27	HAO	1	A4111 2472L	+Table,Sq-Edge Lam 24D 72W 29H +kale +inner tone light	\$ 686.00	\$ 187.28	\$ 187.28	72.700
			8X HF					
28	HST	43	AD10PB	+Side Chair,Stk,Aside,Nonuphol Outer Back +metal arms +glide +medium tone +crepe-Pr Cat 2 +crepe raisin	\$ 285.00	\$ 136.80	\$ 5,882.40	52.000
			MA SG MT 92 12					
29	HST	6	AE123AWB	+Chair,Aeron Wk,2-Stg Pneu.,Tit Lim/Seat,Adj Arms,B Sz +adjustable PostureFit™ support +graphite +2 1/2" hard caster, black yoke, carpet +black +pellicle® classic-Pr Cat 1 +pellicle® classic jade	\$ 1,220.00	\$ 492.88	\$ 2,957.28	59.600
			PJ G1 BB BK 3D 12					
30	HEI	21	E1110.3824G	+Frame,Pwr 4-Circ W/Com Pt Lc 38H 24W +inner tone light +inner tone light	\$ 421.00	\$ 119.14	\$ 2,501.94	71.700
			HF HF					
31	HEI	8	E1110.3830J	+Frame,Npwr Access Holes W/Com Pt Lc 38H 30W +inner tone light +inner tone light	\$ 329.00	\$ 93.11	\$ 744.88	71.700
			HF HF					
32	HEI	7	E1110.3830G	+Frame,Pwr 4-Circ W/Com Pt Lc 38H 30W +inner tone light +inner tone light	\$ 452.00	\$ 127.92	\$ 895.44	71.700
			HF HF					
33	HEI	2	E1110.3836J	+Frame,Npwr Access Holes W/Com Pt Lc 38H 36W +inner tone light +inner tone light	\$ 360.00	\$ 101.88	\$ 203.76	71.700
			HF HF					
34	HEI	5	E1110.3836G	+Frame,Pwr 4-Circ W/Com Pt Lc 38H 36W +inner tone light +inner tone light	\$ 483.00	\$ 136.69	\$ 683.45	71.700
			HF HF					

LEE CO. HENDRY ST. 1ST FLOOR: CITY
 F2214CITY.SP4

Item	Cat	Qty	Part Number	Part Description	List \$	Sell \$	Ext Sell \$	Sell-%
35	HEI	5	E1110.3842G	+Frame,Pwr 4-Circ W/Com Pt Lc 38H 42W	\$ 514.00	\$ 145.46	\$ 727.30	71.700
			HF	+inner tone light				
			HF	+inner tone light				
36	HEI	1	E1110.3848J	+Frame,Npwr Access Holes W/Com Pt Lc 38H 48W	\$ 421.00	\$ 119.14	\$ 119.14	71.700
			HF	+inner tone light				
			HF	+inner tone light				
37	HEI	17	E1110.3848G	+Frame,Pwr 4-Circ W/Com Pt Lc 38H 48W	\$ 544.00	\$ 153.95	\$ 2,617.15	71.700
			HF	+inner tone light				
			HF	+inner tone light				
38	HEI	1	E1110.5418N	+Frame,Npwr No Access 54H 18W	\$ 318.00	\$ 89.99	\$ 89.99	71.700
			HF	+inner tone light				
			HF	+inner tone light				
39	HEI	5	E1110.5424J	+Frame,Npwr Access Holes W/Com Pt Lc 54H 24W	\$ 340.00	\$ 96.22	\$ 481.10	71.700
			HF	+inner tone light				
			HF	+inner tone light				
40	HEI	14	E1110.5424G	+Frame,Pwr 4-Circ W/Com Pt Lc 54H 24W	\$ 463.00	\$ 131.03	\$ 1,834.42	71.700
			HF	+inner tone light				
			HF	+inner tone light				
41	HEI	18	E1110.5430J	+Frame,Npwr Access Holes W/Com Pt Lc 54H 30W	\$ 371.00	\$ 104.99	\$ 1,889.82	71.700
			HF	+inner tone light				
			HF	+inner tone light				
42	HEI	18	E1110.5430G	+Frame,Pwr 4-Circ W/Com Pt Lc 54H 30W	\$ 494.00	\$ 139.80	\$ 2,516.40	71.700
			HF	+inner tone light				
			HF	+inner tone light				
43	HEI	2	E1110.5436J	+Frame,Npwr Access Holes W/Com Pt Lc 54H 36W	\$ 402.00	\$ 113.77	\$ 227.54	71.700
			HF	+inner tone light				
			HF	+inner tone light				
44	HEI	5	E1110.5436G	+Frame,Pwr 4-Circ W/Com Pt Lc 54H 36W	\$ 525.00	\$ 148.58	\$ 742.90	71.700
			HF	+inner tone light				
			HF	+inner tone light				
45	HEI	6	E1110.5442G	+Frame,Pwr 4-Circ W/Com Pt Lc 54H 42W	\$ 556.00	\$ 157.35	\$ 944.10	71.700
			HF	+inner tone light				
			HF	+inner tone light				
46	HEI	13	E1110.5448G	+Frame,Pwr 4-Circ W/Com Pt Lc 54H 48W	\$ 586.00	\$ 165.84	\$ 2,155.92	71.700
			HF	+inner tone light				
			HF	+inner tone light				
47	HEI	3	E1110.7018N	+Frame,Npwr No Access 70H 18W	\$ 360.00	\$ 101.88	\$ 305.64	71.700
			HF	+inner tone light				
			HF	+inner tone light				
48	HEI	12	E1110.7024J	+Frame,Npwr Access Holes W/Com Pt Lc 70H 24W	\$ 382.00	\$ 108.11	\$ 1,297.32	71.700
			HF	+inner tone light				
			HF	+inner tone light				
49	HEI	38	E1110.7024G	+Frame,Pwr 4-Circ W/Com Pt Lc 70H 24W	\$ 505.00	\$ 142.92	\$ 5,430.96	71.700
			HF	+inner tone light				
			HF	+inner tone light				
50	HEI	25	E1110.7030J	+Frame,Npwr Access Holes W/Com Pt Lc 70H 30W	\$ 413.00	\$ 116.88	\$ 2,922.00	71.700
			HF	+inner tone light				
			HF	+inner tone light				
51	HEI	51	E1110.7030G	+Frame,Pwr 4-Circ W/Com Pt Lc 70H 30W	\$ 536.00	\$ 151.69	\$ 7,736.19	71.700
			HF	+inner tone light				
			HF	+inner tone light				
52	HEI	1	E1110.7036J	+Frame,Npwr Access Holes W/Com Pt Lc 70H 36W	\$ 444.00	\$ 125.65	\$ 125.65	71.700
			HF	+inner tone light				
			HF	+inner tone light				
53	HEI	19	E1110.7036G	+Frame,Pwr 4-Circ W/Com Pt Lc 70H 36W	\$ 567.00	\$ 160.46	\$ 3,048.74	71.700
			HF	+inner tone light				
			HF	+inner tone light				
54	HEI	18	E1110.7042G	+Frame,Pwr 4-Circ W/Com Pt Lc 70H 42W	\$ 598.00	\$ 169.23	\$ 3,046.14	71.700
			HF	+inner tone light				
			HF	+inner tone light				

LEE CO. HENDRY ST. 1ST FLOOR: CITY
 F2214CITY.SP4

Item	Cat	Qty	Part Number	Part Description	List \$	Sell \$	Ext Sell \$	Sell- %
55	HEI	2	E1110.7048J	+Frame,Npwr Access Holes W/Com Pt Lc 70H 48W	\$ 505.00	\$ 142.92	\$ 285.84	71.700
			HF	+inner tone light				
			HF	+inner tone light				
56	HEI	21	E1110.7048G	+Frame,Pwr 4-Circ W/Com Pt Lc 70H 48W	\$ 628.00	\$ 177.72	\$ 3,732.12	71.700
			HF	+inner tone light				
			HF	+inner tone light				
57	HEI	3	E1110.8618N	+Frame,Npwr No Access 86H 18W	\$ 401.00	\$ 113.48	\$ 340.44	71.700
			HF	+inner tone light				
			HF	+inner tone light				
58	HEI	8	E1110.8624G	+Frame,Pwr 4-Circ W/Com Pt Lc 86H 24W	\$ 547.00	\$ 154.80	\$ 1,238.40	71.700
			HF	+inner tone light				
			HF	+inner tone light				
59	HEI	3	E1110.8630J	+Frame,Npwr Access Holes W/Com Pt Lc 86H 30W	\$ 455.00	\$ 128.77	\$ 386.31	71.700
			HF	+inner tone light				
			HF	+inner tone light				
60	HEI	20	E1110.8630G	+Frame,Pwr 4-Circ W/Com Pt Lc 86H 30W	\$ 578.00	\$ 163.57	\$ 3,271.40	71.700
			HF	+inner tone light				
			HF	+inner tone light				
61	HEI	8	E1110.8636J	+Frame,Npwr Access Holes W/Com Pt Lc 86H 36W	\$ 486.00	\$ 137.54	\$ 1,100.32	71.700
			HF	+inner tone light				
			HF	+inner tone light				
62	HEI	8	E1110.8636G	+Frame,Pwr 4-Circ W/Com Pt Lc 86H 36W	\$ 609.00	\$ 172.35	\$ 1,378.80	71.700
			HF	+inner tone light				
			HF	+inner tone light				
63	HEI	1	E1110.8642J	+Frame,Npwr Access Holes W/Com Pt Lc 86H 42W	\$ 517.00	\$ 146.31	\$ 146.31	71.700
			HF	+inner tone light				
			HF	+inner tone light				
64	HEI	3	E1110.8642G	+Frame,Pwr 4-Circ W/Com Pt Lc 86H 42W	\$ 640.00	\$ 181.12	\$ 543.36	71.700
			HF	+inner tone light				
			HF	+inner tone light				
65	HEI	1	E1110.8648J	+Frame,Npwr Access Holes W/Com Pt Lc 86H 48W	\$ 547.00	\$ 154.80	\$ 154.80	71.700
			HF	+inner tone light				
			HF	+inner tone light				
66	HEI	1	E1110.8648G	+Frame,Pwr 4-Circ W/Com Pt Lc 86H 48W	\$ 670.00	\$ 189.61	\$ 189.61	71.700
			HF	+inner tone light				
			HF	+inner tone light				
67	HEI	2	E1115.42L	@Dr Frame,W/Dr L Swing 42W	\$ 3,624.00	\$ 1,025.59	\$ 2,051.18	71.700
			PW	@paint-grade birch				
			HF	@inner tone light				
			HF	@inner tone light				
68	HEI	2	E1115.42R	@Dr Frame,W/Dr R Swing 42W	\$ 3,624.00	\$ 1,025.59	\$ 2,051.18	71.700
			PW	@paint-grade birch				
			HF	@inner tone light				
			HF	@inner tone light				
69	HEI	4	E1210.38	+Wall Start 38H	\$ 67.00	\$ 18.96	\$ 75.84	71.700
			HF	+inner tone light				
70	HEI	9	E1210.70	+Wall Start 70H	\$ 78.00	\$ 22.07	\$ 198.63	71.700
			HF	+inner tone light				
71	HEI	1	E1210.86	+Wall Start 86H	\$ 86.00	\$ 24.34	\$ 24.34	71.700
			HF	+inner tone light				
72	HEI	10	E1220.38SRE	+Conn,2-Way 90 Vinyl,Pwr 38H	\$ 198.00	\$ 56.03	\$ 560.30	71.700
			HF	+inner tone light				
			HF	+inner tone light				
			HF	+inner tone light				
73	HEI	11	E1220.54SRE	+Conn,2-Way 90 Vinyl,Pwr 54H	\$ 224.00	\$ 63.39	\$ 697.29	71.700
			HF	+inner tone light				
			HF	+inner tone light				
			HF	+inner tone light				

LEE CO. HENDRY ST. 1ST FLOOR: CITY
F2214CITY.SP4

Item	Cat	Qty	Part Number	Part Description	List \$	Sell \$	Ext Sell \$	Sell- %
74	HEI	27	E1220.70SRE	+Conn,2-Way 90 Vinyl,Pwr 70H HF HF HF +inner tone light +inner tone light +inner tone light	\$ 243.00	\$ 68.77	\$ 1,856.79	71.700
75	HEI	6	E1220.86SRE	+Conn,2-Way 90 Vinyl,Pwr 86H HF HF HF +inner tone light +inner tone light +inner tone light	\$ 270.00	\$ 76.41	\$ 458.46	71.700
76	HEI	1	E1222.38SE	+Spacer Vinyl,Pwr 38H HF HF HF HF +inner tone light +inner tone light +inner tone light +inner tone light	\$ 212.00	\$ 60.00	\$ 60.00	71.700
77	HEI	1	E1222.70SE	+Spacer Vinyl,Pwr 70H HF HF HF HF +inner tone light +inner tone light +inner tone light +inner tone light	\$ 256.00	\$ 72.45	\$ 72.45	71.700
78	HEI	4	E1222.86SE	+Spacer Vinyl,Pwr 86H HF HF HF HF +inner tone light +inner tone light +inner tone light +inner tone light	\$ 282.00	\$ 79.81	\$ 319.24	71.700
79	HEI	2	E1230.38SE	+Conn,3-Way 90 Vinyl,Pwr 38H HF HF HF +inner tone light +inner tone light +inner tone light	\$ 256.00	\$ 72.45	\$ 144.90	71.700
80	HEI	7	E1230.54SE	+Conn,3-Way 90 Vinyl,Pwr 54H HF HF HF +inner tone light +inner tone light +inner tone light	\$ 287.00	\$ 81.22	\$ 568.54	71.700
81	HEI	28	E1230.70SE	+Conn,3-Way 90 Vinyl,Pwr 70H HF HF HF +inner tone light +inner tone light +inner tone light	\$ 320.00	\$ 90.56	\$ 2,535.68	71.700
82	HEI	9	E1230.86SE	+Conn,3-Way 90 Std Vinyl,Pwr 86H HF HF HF +inner tone light +inner tone light +inner tone light	\$ 354.00	\$ 100.18	\$ 901.62	71.700
83	HEI	1	E1240.54FE	+Conn,4-Way 90,Pwr 54H HF +inner tone light	\$ 333.00	\$ 94.24	\$ 94.24	71.700
84	HEI	5	E1240.70FE	+Conn,4-Way 90,Pwr 70H HF +inner tone light	\$ 365.00	\$ 103.30	\$ 516.50	71.700
85	HEI	2	E1240.86FE	+Conn,4-Way 90,Pwr 86H HF +inner tone light	\$ 403.00	\$ 114.05	\$ 228.10	71.700
86	HEI	21	E1250.38S	+Fin End,Std 38H HF +inner tone light	\$ 49.00	\$ 13.87	\$ 291.27	71.700
87	HEI	30	E1250.54S	+Fin End,Std 54H HF +inner tone light	\$ 54.00	\$ 15.28	\$ 458.40	71.700
88	HEI	41	E1250.70S	+Fin End,Std 70H HF +inner tone light	\$ 59.00	\$ 16.70	\$ 684.70	71.700
89	HEI	1	E1250.86S	+Fin End,Std 86H HF +inner tone light	\$ 67.00	\$ 18.96	\$ 18.96	71.700
90	HEI	32	E1251.16S	+Ch of Ht Fin End Std 16H HF +inner tone light	\$ 38.00	\$ 10.75	\$ 344.00	71.700
91	HEI	19	E1251.32S	+Ch of Ht Fin End Std 32H HF +inner tone light	\$ 46.00	\$ 13.02	\$ 247.38	71.700
92	HEI	25	E1322.06E	+Power Entry,Ext. Dir Con 4-Circ,6FL L	\$ 120.00	\$ 33.96	\$ 849.00	71.700
93	HEI	10	E1411.1624M	+Tile,Glazed Window Mid/Bot 16H 24W HF TR +inner tone light +clear	\$ 83.00	\$ 23.49	\$ 234.90	71.700

LEE CO. HENDRY ST. 1ST FLOOR: CITY
F2214CITY.SP4

Item	Cat	Qty	Part Number	Part Description	List \$	Sell \$	Ext Sell \$	Sell- %
94	HEI	28	E1411.1624T	+Tile,Glazed Window Top 16H 24W HF TR +inner tone light +clear	\$ 83.00	\$ 23.49	\$ 657.72	71.700
95	HEI	12	E1411.1630M	+Tile,Glazed Window Mid/Bot 16H 30W HF TR +inner tone light +clear	\$ 92.00	\$ 26.04	\$ 312.48	71.700
96	HEI	52	E1411.1630T	+Tile,Glazed Window Top 16H 30W HF TR +inner tone light +clear	\$ 92.00	\$ 26.04	\$ 1,354.08	71.700
97	HEI	16	E1411.1636M	+Tile,Glazed Window Mid/Bot 16H 36W HF TR +inner tone light +clear	\$ 103.00	\$ 29.15	\$ 466.40	71.700
98	HEI	8	E1411.1636T	+Tile,Glazed Window Top 16H 36W HF TR +inner tone light +clear	\$ 103.00	\$ 29.15	\$ 233.20	71.700
99	HEI	2	E1411.1642T	+Tile,Glazed Window Top 16H 42W HF TR +inner tone light +clear	\$ 114.00	\$ 32.26	\$ 64.52	71.700
100	HEI	16	E1411.1648T	+Tile,Glazed Window Top 16H 48W HF TR +inner tone light +clear	\$ 127.00	\$ 35.94	\$ 575.04	71.700
101	HEI	56	E1420.1618F	+Tile,Face Fabric 16H 18W 1Z 02 +penumbra-Pr Cat 1 +penumbra phoebe	\$ 53.00	\$ 15.00	\$ 840.00	71.700
102	HEI	8	E1420.1618P	+Tile,Face Painted 16H 18W HF +inner tone light	\$ 38.00	\$ 10.75	\$ 86.00	71.700
103	HEI	290	E1420.1624F	+Tile,Face Fabric 16H 24W 1Z 02 +penumbra-Pr Cat 1 +penumbra phoebe	\$ 59.00	\$ 16.70	\$ 4,843.00	71.700
104	HEI	310	E1420.1624P	+Tile,Face Painted 16H 24W HF +inner tone light	\$ 41.00	\$ 11.60	\$ 3,596.00	71.700
105	HEI	525	E1420.1630F	+Tile,Face Fabric 16H 30W 1Z 02 +penumbra-Pr Cat 1 +penumbra phoebe	\$ 64.00	\$ 18.11	\$ 9,507.75	71.700
106	HEI	430	E1420.1630P	+Tile,Face Painted 16H 30W HF +inner tone light	\$ 45.00	\$ 12.74	\$ 5,478.20	71.700
107	HEI	215	E1420.1636F	+Tile,Face Fabric 16H 36W 1Z 02 +penumbra-Pr Cat 1 +penumbra phoebe	\$ 71.00	\$ 20.09	\$ 4,319.35	71.700
108	HEI	125	E1420.1636P	+Tile,Face Painted 16H 36W HF +inner tone light	\$ 50.00	\$ 14.15	\$ 1,768.75	71.700
109	HEI	75	E1420.1642F	+Tile,Face Fabric 16H 42W 1Z 02 +penumbra-Pr Cat 1 +penumbra phoebe	\$ 77.00	\$ 21.79	\$ 1,634.25	71.700
110	HEI	116	E1420.1642P	+Tile,Face Painted 16H 42W HF +inner tone light	\$ 56.00	\$ 15.85	\$ 1,838.60	71.700
111	HEI	116	E1420.1648F	+Tile,Face Fabric 16H 48W 1Z 02 +penumbra-Pr Cat 1 +penumbra phoebe	\$ 84.00	\$ 23.77	\$ 2,757.32	71.700
112	HEI	160	E1420.1648P	+Tile,Face Painted 16H 48W HF +inner tone light	\$ 61.00	\$ 17.26	\$ 2,761.60	71.700
113	HEI	10	E1422.1624	+Tile,Tackable 16H 24W 64 24 +flannel-Pr Cat 4 +flannel grape	\$ 102.00	\$ 28.87	\$ 288.70	71.700
114	HEI	22	E1422.1630	+Tile,Tackable 16H 30W 64 24 +flannel-Pr Cat 4 +flannel grape	\$ 110.00	\$ 31.13	\$ 684.86	71.700

LEE CO. HENDRY ST. 1ST FLOOR: CITY
F2214CITY.SP4

Item	Cat	Qty	Part Number	Part Description	List \$	Sell \$	Ext Sell \$	Sell- %
115	HEI	10	E1422.1636	+Tile,Tackable 16H 36W 64 24 +flannel-Pr Cat 4 +flannel grape	\$ 121.00	\$ 34.24	\$ 342.40	71.700
116	HEI	28	E1422.1642	+Tile,Tackable 16H 42W 64 24 +flannel-Pr Cat 4 +flannel grape	\$ 135.00	\$ 38.21	\$ 1,069.88	71.700
117	HEI	39	E1422.1648	+Tile,Tackable 16H 48W 64 24 +flannel-Pr Cat 4 +flannel grape	\$ 144.00	\$ 40.75	\$ 1,589.25	71.700
118	HEI	29	E1425.1624	+Tile,Rail 16H 24W HF +inner tone light	\$ 126.00	\$ 35.66	\$ 1,034.14	71.700
119	HEI	61	E1425.1630	+Tile,Rail 16H 30W HF +inner tone light	\$ 141.00	\$ 39.90	\$ 2,433.90	71.700
120	HEI	19	E1425.1636	+Tile,Rail 16H 36W HF +inner tone light	\$ 154.00	\$ 43.58	\$ 828.02	71.700
121	HEI	5	E1425.1642	+Tile,Rail 16H 42W HF +inner tone light	\$ 169.00	\$ 47.83	\$ 239.15	71.700
122	HEI	14	E1425.1648	+Tile,Rail 16H 48W HF +inner tone light	\$ 183.00	\$ 51.79	\$ 725.06	71.700
123	HEI	4	E1690.MWS	+Dr Lever Handle,Lock Sel/Std Bevel CK +satin chrome	\$ 603.00	\$ 170.65	\$ 682.60	71.700
124	HEI	1	E2170.3080L	+Peninsula,Sq-Edge Rect,Column 30D 60W 8X HF SM +kale +inner tone light +on module	\$ 827.00	\$ 234.04	\$ 234.04	71.700
125	HEI	7	E2210.2436L	+Work Surf,Sq-Edge Rect Lam 24D 36W 8X HF SM +kale +inner tone light +on module	\$ 297.00	\$ 84.05	\$ 588.35	71.700
126	HEI	18	E2210.2442L	+Work Surf,Sq-Edge Rect Lam 24D 42W 8X HF SM +kale +inner tone light +on module	\$ 324.00	\$ 91.69	\$ 1,650.42	71.700
127	HEI	18	E2210.2448L	+Work Surf,Sq-Edge Rect Lam 24D 48W 8X HF SM +kale +inner tone light +on module	\$ 351.00	\$ 99.33	\$ 1,787.94	71.700
128	HEI	3	E2210.2460L	+Work Surf,Sq-Edge Rect Lam 24D 60W 8X HF SM +kale +inner tone light +on module	\$ 446.00	\$ 126.22	\$ 378.66	71.700
129	HEI	2	E2210.2466L	+Work Surf,Sq-Edge Rect Lam 24D 66W 8X HF SM +kale +inner tone light +on module	\$ 493.00	\$ 139.52	\$ 279.04	71.700
130	HEI	18	E2210.2472L	+Work Surf,Sq-Edge Rect Lam 24D 72W 8X HF SM +kale +inner tone light +on module	\$ 540.00	\$ 152.82	\$ 2,750.76	71.700
131	HEI	1	E2210.2496L	+Work Surf,Sq-Edge Rect Lam 24D 96W 8X HF SM +kale +inner tone light +on module	\$ 682.00	\$ 193.01	\$ 193.01	71.700
132	HEI	3	E2210.3036L	+Work Surf,Sq-Edge Rect Lam 30D 36W 8X HF SM +kale +inner tone light +on module	\$ 365.00	\$ 103.30	\$ 309.90	71.700
133	HEI	2	E2210.3042L	+Work Surf,Sq-Edge Rect Lam 30D 42W 8X HF SM +kale +inner tone light +on module	\$ 405.00	\$ 114.62	\$ 229.24	71.700

LEE CO. HENDRY ST. 1ST FLOOR: CITY
F2214CITY.SP4

Item	Cat	Qty	Part Number	Part Description	List \$	Sell \$	Ext Sell \$	Sell- %
134	HEI	11	E2210.3048L	+Work Surf,Sq-Edge Rect Lam 30D 48W +kale +inner tone light +on module	\$ 446.00	\$ 126.22	\$ 1,388.42	71.700
			8X HF SM					
135	HEI	8	E2210.3060L	+Work Surf,Sq-Edge Rect Lam 30D 60W +kale +inner tone light +on module	\$ 567.00	\$ 160.46	\$ 1,283.68	71.700
			8X HF SM					
136	HEI	12	E2210.3066L	+Work Surf,Sq-Edge Rect Lam 30D 66W +kale +inner tone light +on module	\$ 632.00	\$ 178.86	\$ 2,146.32	71.700
			8X HF SM					
137	HEI	37	E2210.3072L	+Work Surf,Sq-Edge Rect Lam 30D 72W +kale +inner tone light +on module	\$ 696.00	\$ 196.97	\$ 7,287.89	71.700
			8X HF SM					
138	HEI	7	E2210.3078L	+Work Surf,Sq-Edge Rect Lam 30D 78W +kale +inner tone light +on module	\$ 740.00	\$ 209.42	\$ 1,465.94	71.700
			8X HF SM					
139	HEI	3	E2210.3084L	+Work Surf,Sq-Edge Rect Lam 30D 84W +kale +inner tone light +on module	\$ 783.00	\$ 221.59	\$ 664.77	71.700
			8X HF SM					
140	HEI	1	E2210.3090L	+Work Surf,Sq-Edge Rect Lam 30D 90W +kale +inner tone light +on module	\$ 824.00	\$ 233.19	\$ 233.19	71.700
			8X HF SM					
141	HEI	6	E2210.3096L	+Work Surf,Sq-Edge Rect Lam 30D 96W +kale +inner tone light +on module	\$ 864.00	\$ 244.51	\$ 1,467.06	71.700
			8X HF SM					
142	HEI	1	E2232.3042L	+Work Surf,Sq-Edge Cor Lam 30D 42W +kale +inner tone light +on module	\$ 600.00	\$ 169.80	\$ 169.80	71.700
			8X HF SM					
143	HEI	26	E2280.24L	+Support Panel,Wk Surf Lam,End 24D +inner tone light +inner tone light +inner tone light	\$ 304.00	\$ 86.03	\$ 2,236.78	71.700
			HF HF HF					
144	HEI	24	E2280.30L	+Support Panel,Wk Surf Lam,End 30D +inner tone light +inner tone light +inner tone light	\$ 345.00	\$ 97.64	\$ 2,343.36	71.700
			HF HF HF					
145	HEI	4	E2281.L	+Support Panel,Wk Surf Lam,Mid-Run +inner tone light +inner tone light +inner tone light	\$ 304.00	\$ 86.03	\$ 344.12	71.700
			HF HF HF					
146	HEI	4	E2812.24LN	+Trans Surf,Sq-Edge Rect End Lam,No Cutout 24W +kale	\$ 177.00	\$ 50.09	\$ 200.36	71.700
			8X					
147	HEI	3	E2812.36LN	+Trans Surf,Sq-Edge Rect End Lam,No Cutout 36W +kale	\$ 198.00	\$ 56.03	\$ 168.09	71.700
			8X					
148	HEI	3	E2812.48LN	+Trans Surf,Sq-Edge Rect End Lam,No Cutout 48W +kale	\$ 212.00	\$ 60.00	\$ 180.00	71.700
			8X					
149	HEI	8	E3212.24F	+Flip Dr Unit,B-Style Fabric W/Lock 13D 24W +keyed differently +inner tone light +on module +iota™-Pr Cat 4 +iota™ marsh ice	\$ 387.00	\$ 109.52	\$ 876.16	71.700
			KD HF SM 32 12					

LEE CO. HENDRY ST. 1ST FLOOR: CITY
F2214CITY.SP4

Item	Cat	Qty	Part Number	Part Description	List \$	Sell \$	Ext Sell \$	Sell-%
150	HEI	9	E3212.30F	+Flip Dr Unit,B-Style Fabric W/Lock 13D 30W	\$ 406.00	\$ 114.90	\$ 1,034.10	71.700
			KD	+keyed differently				
			HF	+inner tone light				
			SM	+on module				
			32	+iota™-Pr Cat 4				
			12	+iota™ marsh ice				
151	HEI	7	E3212.36F	+Flip Dr Unit,B-Style Fabric W/Lock 13D 36W	\$ 434.00	\$ 122.82	\$ 859.74	71.700
			KD	+keyed differently				
			HF	+inner tone light				
			SM	+on module				
			32	+iota™-Pr Cat 4				
			12	+iota™ marsh ice				
152	HEI	8	E3212.42F	+Flip Dr Unit,B-Style Fabric W/Lock 13D 42W	\$ 463.00	\$ 131.03	\$ 1,048.24	71.700
			KD	+keyed differently				
			HF	+inner tone light				
			SM	+on module				
			32	+iota™-Pr Cat 4				
			12	+iota™ marsh ice				
153	HEI	10	E3212.48F	+Flip Dr Unit,B-Style Fabric W/Lock 13D 48W	\$ 486.00	\$ 137.54	\$ 1,375.40	71.700
			KD	+keyed differently				
			HF	+inner tone light				
			SM	+on module				
			32	+iota™-Pr Cat 4				
			12	+iota™ marsh ice				
154	HEI	16	E3230.24	+Shelf,B-Style Open 7-1/2H 24W	\$ 97.00	\$ 27.45	\$ 439.20	71.700
			HF	+inner tone light				
155	HEI	40	E3230.30	+Shelf,B-Style Open 7-1/2H 30W	\$ 102.00	\$ 28.87	\$ 1,154.80	71.700
			HF	+inner tone light				
156	HEI	8	E3230.36	+Shelf,B-Style Open 7-1/2H 36W	\$ 109.00	\$ 30.85	\$ 246.80	71.700
			HF	+inner tone light				
157	HEI	15	E3230.42	+Shelf,B-Style Open 7-1/2H 42W	\$ 117.00	\$ 33.11	\$ 496.65	71.700
			HF	+inner tone light				
158	HEI	13	E3230.48	+Shelf,B-Style Open 7-1/2H 48W	\$ 121.00	\$ 34.24	\$ 445.12	71.700
			HF	+inner tone light				
159	HST	79	EE122AB	+Chair,Ergon 3 Pneu,Adj Arms,Knee Tilt,Sz B	\$ 906.00	\$ 292.91	\$ 23,139.89	67.670
			N4	+not adjustable				
			MT	+medium tone				
			BC	+2" hd dbl wl caster, carpet				
			U6	+nonupholstered				
			MT	+medium tone				
			92	+crepe-Pr Cat 2				
			12	+crepe raisin				
160	HST	3	EE711NK	@Stool,Ergon 3 Low,No Arms,Mid-Bk,Sz B	\$ 900.00	\$ 290.97	\$ 872.91	67.670
			N4	@not adjustable				
			MT	@medium tone				
			BC	@2" hd dbl wl caster, carpet				
			U6	@nonupholstered				
			92	@crepe-Pr Cat 2				
			12	+crepe raisin				
161	HMH	2	ET109L	+Table,Round Contract Base Lam Top 28.5H 42Dia	\$ 540.00	\$ 147.42	\$ 294.84	72.700
			8X	+kale Skipped Option				
162	HMH	1	ET143L	+Table,Rect Seg Base Vin Edge/Lam Top 28.5H	\$ 1,300.00	\$ 354.90	\$ 354.90	72.700
			8X	36D 72W +kale Skipped Option				
163	HMH	1	ET161L	+Table,Oval Seg Base Vin Edg/Lam Top 28.5H 54D	\$ 4,075.00	\$ 1,112.48	\$ 1,112.48	72.700
			8X	156W +kale Skipped Option				
164	MER	64	F16-1822-BBF	+Freestanding Ped Std Pull 18W 22D 26-1/4H (BBF)	\$ 630.00	\$ 241.79	\$ 15,474.56	61.620
			TS	+Textured Steel				
			HF	+Inner tone Light non-metallic				
			T2	+Square Metal Top 1-1/4				
			KD	+Black - Keyed Differently				
			B2	+Base 1-1/2				
			CB	+Counterweight(recommended)				
			C	+Std. Compressor				

LEE CO. HENDRY ST. 1ST FLOOR: CITY
F2214CITY.SP4

Item	Cat	Qty	Part Number	Part Description	List \$	Sell \$	Ext Sell \$	Sell-%
165	MER	43	F16-1822-FF	+Freestanding Ped Std Pull 18W 22D 26-1/4H (FF)	\$ 609.00	\$ 233.73	\$ 10,050.39	61.620
			TS	+Textured Steel				
			HF	+inner tone Light non-metallic				
			T2	+Square Metal Top 1-1/4				
			KD	+Black - Keyed Differently				
			B2	+Base 1-1/2				
			CB	+Counterweight(recommended)				
			C	+Std. Compressor				
166	HMU	63	G5010.	+Drw,Pencil 21W 16D	\$ 42.00	\$ 11.47	\$ 722.61	72.700
			HF	+inner tone light				
167	HMU	24	G6120.24MEN	+Task Light,E.E. Electronic Ballast/No Dimmer 24W	\$ 210.00	\$ 57.33	\$ 1,375.92	72.700
			HF	+inner tone light				
168	HMU	42	G6120.30MEN	+Task Light,E.E. Electronic Ballast/No Dimmer 30W	\$ 218.00	\$ 59.51	\$ 2,499.42	72.700
			HF	+inner tone light				
169	HMU	12	G6120.36MEN	+Task Light,E.E. Electronic Ballast/No Dimmer 36W	\$ 224.00	\$ 61.15	\$ 733.80	72.700
			HF	+inner tone light				
170	HMU	13	G6120.42MEN	+Task Light,E.E. Electronic Ballast/No Dimmer 42W	\$ 234.00	\$ 63.88	\$ 830.44	72.700
			HF	+inner tone light				
171	HMU	22	G6120.48MEN	+Task Light,E.E. Electronic Ballast/No Dimmer 48W	\$ 239.00	\$ 65.25	\$ 1,435.50	72.700
			HF	+inner tone light				
172	HMU	44	G7715.04K	+Keybd Tray,Fully Adj,Std-Length Arm,Knob Adj	\$ 356.00	\$ 97.19	\$ 4,276.36	72.700
			HF	+inner tone light				
173	HMU	1	G7715.08K	+Keybd Tray,Fully Adj,Knob Adj 21In Trk	\$ 382.00	\$ 104.29	\$ 104.29	72.700
			HF	+inner tone light				
174	HMU	45	G7742.	+Mouse Tray,Wk Surf Att,Adj/Storable	\$ 206.00	\$ 56.24	\$ 2,530.80	72.700
175	HCE	1	ZERLA	@Vary Easy Etho Sq-Edge Vinyl Frt Rect Wk Surf,w/	\$ 338.00	\$ 95.65	\$ 95.65	71.700
			24	wire/grmt,Lam Top				
			46	@24D				
			9A	@24D 45.5W				
			8X	@W/Cbl Mgmt Trgh-No Gap (Std Etho Gap)				
			...	@Kale				
			HF	Skipped Option				
			SM	@Inner Tone Light Supt				
				@On Module				
176	HCE	1	ZERLA	@Vary Easy Etho Sq-Edge Vinyl Frt Rect Wk Surf,w/	\$ 375.00	\$ 106.13	\$ 106.13	71.700
			24	wire/grmt,Lam Top				
			52	@24D				
			9A	@24D 51.5W				
			...	@W/Cbl Mgmt Trgh-No Gap (Std Etho Gap)				
			HF	Skipped Option				
			SM	@Inner Tone Light Supt				
				@On Module				
177	HCE	2	ZERLA	@Vary Easy Etho Sq-Edge Vinyl Frt Rect Wk Surf,w/	\$ 423.00	\$ 119.71	\$ 239.42	71.700
			24	wire/grmt,Lam Top				
			58	@24D				
			9A	@24D 57.5W				
			8X	@W/Cbl Mgmt Trgh-No Gap (Std Etho Gap)				
			...	@Kale				
			HF	Skipped Option				
			SM	@Inner Tone Light Supt				
				@On Module				
178	HCE	1	ZERLA	@Vary Easy Etho Sq-Edge Vinyl Frt Rect Wk Surf,w/	\$ 470.00	\$ 133.01	\$ 133.01	71.700
			24	wire/grmt,Lam Top				
			64	@24D				
			9A	@24D 63.5W				
			8X	@W/Cbl Mgmt Trgh-No Gap (Std Etho Gap)				
			...	@Kale				
			HF	Skipped Option				
			SM	@Inner Tone Light Supt				
				@On Module				
179	HCE	1	ZERLA	@Vary Easy Etho Sq-Edge Vinyl Frt Rect Wk Surf,w/	\$ 718.00	\$ 203.19	\$ 203.19	71.700
			30	wire/grmt,Lam Top				
			76	@30D				
			9A	@30D 75.5W				
			8X	@W/Cbl Mgmt Trgh-No Gap (Std Etho Gap)				
			...	@Kale				
			HF	Skipped Option				
			SM	@Inner Tone Light Supt				
				@On Module				

LEE CO. HENDRY ST. 1ST FLOOR: CITY
F2214CITY.SP4

Item	Cat	Qty	Part Number	Part Description	List \$	Sell \$	Ext Sell \$	Sell-%
180	HCE	2	ZERLA	@Vary Easy Etho Sq-Edge Vinyl Frt Rect Wk Surf,w/ wire/grmt,Lam Top @30D @30D 39.5W @W/Cbl Mgmt Trgh-No Gap (Std Etho Gap) @Kale Skipped Option @Inner Tone Light Supt @On Module	\$ 385.00	\$ 108.96	\$ 217.92	71.700
			30					
			40					
			9A					
			8X					
			...					
			HF					
			SM					
181	HCE	1	ZERLA	@Vary Easy Etho Sq-Edge Vinyl Frt Rect Wk Surf,w/ wire/grmt,Lam Top @30D @30D 63.5W @W/Cbl Mgmt Trgh-No Gap (Std Etho Gap) @Kale Skipped Option @Inner Tone Light Supt @On Module	\$ 600.00	\$ 169.80	\$ 169.80	71.700
			30					
			64					
			9A					
			8X					
			...					
			HF					
			SM					
182	HCE	2	ZESLA	@Vary Easy Etho Sq-Edge Vinyl Frt Rect Penin,Lam Top @36" Deep @72" Long @Std Etho Col Base w/o Cbl Acc Hole @Cantilever @W/Cbl Mgmt Trgh-No Gap (Std Etho Gap) @Kale Skipped Option @Inner Tone Light	\$ 1,011.00	\$ 286.11	\$ 572.22	71.700
			36					
			72					
			B					
			C					
			9A					
			8X					
			...					
			HF					
183	HMU	150	G7110.10	*Paper Tray 10W	\$ 32.00	\$ 8.74	\$ 1,311.00	72.700
			HF	*inner tone light				
184	HMU	75	G7130.	*Diag Tray	\$ 51.00	\$ 13.92	\$ 1,044.00	72.700
			HF	*inner tone light				
185	HMU	70	G7120.8	*Vert Tray 8W	\$ 46.00	\$ 12.56	\$ 879.20	72.700
			HF	*inner tone light				
186	HMU	70	G7310.15	*Mini-Shelf 15W	\$ 46.00	\$ 12.56	\$ 879.20	72.700
			HF	*inner tone light				
187	MA4	4	7868C	Mayline Self-Contained Steel C Plan Files, Five-Drawer File for 30" x 42" sheets - Overall Unit size: 46-3/4"W x 15-3/8"H x 35-3/8"D -NEED TO SELECT FINISH	\$ 1,177.00	\$ 439.84	\$ 1,759.36	62.630
188	MA4	2	7868W	Mayline Flush Base for 30" x 42" Size File, 4"H -NEED TO SELECT FINISH	\$ 196.00	\$ 73.25	\$ 146.50	62.630
189	HVG	1	ZCELA	@Exact Size File Top,Sq-Edge Vinyl Frt,Lam Top @Depth: 30.01in - 54.00in 35-3/8" D @Width: 84.01in - 96.00in 93.5" W @Standard HMI Laminates @Kale Skipped Option TAG: FOR MAYLINE FLAT FILES	\$ 864.00	\$ 292.38	\$ 292.38	66.160
			D02					
			W07					
			EZ					
			8X					
			...					
190	GR3	3	3503S-1-E	GROUP 4 CONTINUUM SERIES CHAIR (SPLIT SEAT & BACK) EPOXY FRAME ANTIQUE WHITE EPOXY FRAME OLYMPIAD VINYL CRETE CURRANT	\$ 612.00	\$ 287.64	\$ 862.92	53.000
			G4-03					
			CRE-55					
191	GR3	7	3503S-4-E	GROUP 4 CONTINUUM SERIES LINK CHAIR (SPLIT SEAT & BACK) EPOXY FRAME ANTIQUE WHITE EPOXY FRAME OLYMPIAD VINYL CRETE CURRANT	\$ 590.00	\$ 277.30	\$ 1,941.10	53.000
			G4-03					
			CRE-55					
192	GR3	3	3503-5-E	GROUP 4 CONTINUUM SERIES LINK END TABLE EPOXY FRAME, PVC EDGE ANTIQUE WHITE EPOXY FRAME STORM NEBULA ANTIQUE WHITE PVC EDGE	\$ 350.00	\$ 164.50	\$ 493.50	53.000
			G4-03					
			4634					
			G4-03					
193	GU1	131	SUBC-INSTALLATION	DELIVERY & INSTALLATION OF CHAIRS PER STATE CONTRACT GUIDELINES	\$ 10.00	\$ 10.00	\$ 1,310.00	0.000
194	GU1	4	SUBC-INSTALLATION	DELIVERY & INSTALLATION OF TABLES PER STATE CONTRACT GUIDELINES	\$ 100.00	\$ 100.00	\$ 400.00	0.000
195	GU1	1	SUBC-INSTALLATION	DELIVERY & INSTALLATION	\$ 60,925.01	\$ 60,925.00	\$ 60,925.00	0.000

LEE CO. HENDRY ST. 1ST FLOOR: CITY
 F2214CITY.SP4

Item	Cat	Qty	Part Number	Part Description	List \$	Sell \$	Ext Sell \$	Sell- %
196	651	68	DESIGN	ADDITIONAL DESIGN SERVICES SPEC ENTERED 4/29/03	\$ 55.01	\$ 55.00	\$ 3,740.00	0.018
				Grand Total			\$ 357,808.93	64.596

LEE CO. HENDRY ST. 2ND FLOOR
F2122.SP4

Item	Cat	Qty	Part Number	Part Description	List \$	Sell \$	Ext Sell \$	Sell- %
1	MER	8	26-3020-2N	+File,FS Lat Std Pull,2 Dwr +textured steel +inner tone light +1 1/4"-high painted metal top with squared edge +keyed differently, black +1 1/2"-high base +counterweight (recommended) +side-to-side filing rail	\$ 690.00	\$ 233.50	\$ 1,868.00	66.160
			TS					
			HF					
			T2					
			KD					
			B2					
			CB					
			9R					
2	MER	22	26-3620-3N	+File,FS Lat Std Pull,3 Dwr +textured steel +inner tone light +1 1/4"-high painted metal top with squared edge +keyed differently, black +1 1/2"-high base +counterweight (recommended) +side-to-side filing rail	\$ 1,006.00	\$ 340.43	\$ 7,489.46	66.160
			TS					
			HF					
			T2					
			KD					
			B2					
			CB					
			9R					
3	MER	1	26-3620-5D	+File,FS Lat Std Pull,1 FD/4 Dwr +textured steel +inner tone light +1 1/4"-high painted metal top with squared edge +keyed differently, black +1 1/2"-high base +counterweight (recommended) +side-to-side filing rail	\$ 1,540.00	\$ 521.14	\$ 521.14	66.160
			TS					
			HF					
			T2					
			KD					
			B2					
			CB					
			9R					
4	MER	3	46-3015-OB-68	+Bookcase Four Adjust Shelves 68-3/8H 30W 15D +Textured Steel +inner tone Light non-metallic +Standard Metal Top 1-1/4 +With Four Shelves +1-1/2in Base TAG: LIBRARY 208	\$ 535.00	\$ 199.93	\$ 599.79	62.630
			TS					
			HF					
			T2					
			NS4					
			B2					
5	MER	2	46-3015-OB-42	+Bookcase Two Adjust Shelves 42-1/8H 30W 15D +Textured Steel +inner tone Light non-metallic +Standard Metal Top 1-1/4 +With Two Shelves +1-1/2in Base TAG: OFFICE 207, 209	\$ 482.00	\$ 180.12	\$ 360.24	62.630
			TS					
			HF					
			T2					
			NS2					
			B2					
6	MER	2	46-3615-OB-68	+Bookcase Four Adjust Shelves 68-3/8H 36W 15D +Textured Steel +inner tone Light non-metallic +Standard Metal Top 1-1/4 +With Four Shelves +1-1/2in Base TAG: LIBRARY 208	\$ 595.00	\$ 222.35	\$ 444.70	62.630
			TS					
			HF					
			T2					
			NS4					
			B2					
7	MEC	2	5-60-TLE	+Task Light,60W	\$ 200.00	\$ 84.84	\$ 169.68	57.580
8	MEC	2	5F-7239-ODR	+Flipper Door Unit w/Tool Rail,72W,Fabric Doors +Comet Fabrics, Category-4 +Comet-Winter Solstice +Textured Steel +inner tone Light non-metallic +Iota Fabrics, Category-4 +Iota-Marsh Ice +Black - Keyed Differently	\$ 1,529.00	\$ 648.60	\$ 1,297.20	57.580
			6B					
			08					
			TS					
			HF					
			32					
			12					
			KD					
9	MEC	2	5F0-4824-D	+Bridge,Full BPnl,48Wx24D +Textured Steel +inner tone Light non-metallic +Laminate Top/PVC Edge +Kale +graphite satin +Single Grommet - Center +Medium Tone	\$ 377.00	\$ 159.92	\$ 319.84	57.580
			TS					
			HF					
			TL					
			8X					
			G2					
			C					
			MT					

LEE CO. HENDRY ST. 2ND FLOOR
F2122.SP4

Item	Cat	Qty	Part Number	Part Description	List \$	Sell \$	Ext Sell \$	Sell-%
10	MEC	2	5F0-7224-LL	+Desk Shell, Full Back Panel, 72Wx24D, LL	\$ 895.00	\$ 379.66	\$ 759.32	57.580
			TS	+Textured Steel				
			HF	+inner tone Light non-metallic				
			TL	+Laminate Top/PVC Edge				
			8X	+Kale				
			G2	+graphite satin				
			C	+Single Grommet - Center				
			MT	+Medium Tone				
11	MEC	2	5F0-7230-LL	+Desk Shell, Full Back Panel, 72Wx30D, LL	\$ 960.00	\$ 407.23	\$ 814.46	57.580
			TS	+Textured Steel				
			HF	+inner tone Light non-metallic				
			TL	+Laminate Top/PVC Edge				
			8X	+Kale				
			G2	+graphite satin				
			L	+Single Grommet - Left				
			MT	+Medium Tone				
12	MEC	2	72-2116-2	+Pencil Drawer, Plastic	\$ 70.00	\$ 29.69	\$ 59.38	57.580
13	HGS	3	A1120.3924G	+Panel, Fabric 4-Circ W/Com Pt Lc 39H 24W	\$ 432.00	\$ 117.94	\$ 353.82	72.700
			HF	+inner tone light				
			HF	+inner tone light				
			7M	+bailey-Pr Cat 1				
			01	+bailey belmont silver				
			7M	+bailey-Pr Cat 1				
			01	+bailey belmont silver				
14	HGS	1	A1120.3942G	+Panel, Fabric 4-Circ W/Com Pt Lc 39H 42W	\$ 525.00	\$ 143.33	\$ 143.33	72.700
			HF	+inner tone light				
			HF	+inner tone light				
			7M	+bailey-Pr Cat 1				
			01	+bailey belmont silver				
			7M	+bailey-Pr Cat 1				
			01	+bailey belmont silver				
15	HGS	98	A1120.4724J	+Panel, Fabric Npwr W/Rcp Com Pt Lc 47H 24W	\$ 327.00	\$ 89.27	\$ 8,748.46	72.700
			HF	+inner tone light				
			HF	+inner tone light				
			7M	+bailey-Pr Cat 1				
			01	+bailey belmont silver				
			7M	+bailey-Pr Cat 1				
			01	+bailey belmont silver				
16	HGS	7	A1120.4730J	+Panel, Fabric Npwr W/Rcp Com Pt Lc 47H 30W	\$ 365.00	\$ 99.65	\$ 697.55	72.700
			HF	+inner tone light				
			HF	+inner tone light				
			7M	+bailey-Pr Cat 1				
			01	+bailey belmont silver				
			7M	+bailey-Pr Cat 1				
			01	+bailey belmont silver				
17	HGS	1	A1120.4736G	+Panel, Fabric 4-Circ W/Com Pt Lc 47H 36W	\$ 540.00	\$ 147.42	\$ 147.42	72.700
			HF	+inner tone light				
			HF	+inner tone light				
			7M	+bailey-Pr Cat 1				
			01	+bailey belmont silver				
			7M	+bailey-Pr Cat 1				
			01	+bailey belmont silver				
18	HGS	2	A1120.6712E	+Panel, Fabric Pwr 4-Circ 67H 12W	\$ 449.00	\$ 122.58	\$ 245.16	72.700
			HF	+inner tone light				
			HF	+inner tone light				
			7M	+bailey-Pr Cat 1				
			01	+bailey belmont silver				
			7M	+bailey-Pr Cat 1				
			01	+bailey belmont silver				
19	HGS	1	A1120.6718E	+Panel, Fabric Pwr 4-Circ 67H 18W	\$ 495.00	\$ 135.14	\$ 135.14	72.700
			HF	+inner tone light				
			HF	+inner tone light				
			7M	+bailey-Pr Cat 1				
			01	+bailey belmont silver				
			7M	+bailey-Pr Cat 1				
			01	+bailey belmont silver				

LEE CO. HENDRY ST. 2ND FLOOR
F2122.SP4

Item	Cat	Qty	Part Number	Part Description	List \$	Sell \$	Ext Sell \$	Sell- %
20	HGS	103	A1120.6724G	+Panel,Fabric 4-Circ W/Com Pt Lc 67H 24W HF HF 7M 01 7M 01	\$ 511.00	\$ 139.50	\$ 14,368.50	72.700
				+inner tone light +inner tone light +bailey-Pr Cat 1 +bailey belmont silver +bailey-Pr Cat 1 +bailey belmont silver				
21	HGS	2	A1120.6724J	+Panel,Fabric Npwr W/Rcp Com Pt Lc 67H 24W HF HF 7M 01 7M 01	\$ 388.00	\$ 105.92	\$ 211.84	72.700
				+inner tone light +inner tone light +bailey-Pr Cat 1 +bailey belmont silver +bailey-Pr Cat 1 +bailey belmont silver				
22	HGS	57	A1120.6730G	+Panel,Fabric 4-Circ W/Com Pt Lc 67H 30W HF HF 7M 01 7M 01	\$ 558.00	\$ 152.33	\$ 8,682.81	72.700
				+inner tone light +inner tone light +bailey-Pr Cat 1 +bailey belmont silver +bailey-Pr Cat 1 +bailey belmont silver				
23	HGS	4	A1120.6730J	+Panel,Fabric Npwr W/Rcp Com Pt Lc 67H 30W HF HF 7M 01 7M 01	\$ 435.00	\$ 118.76	\$ 475.04	72.700
				+inner tone light +inner tone light +bailey-Pr Cat 1 +bailey belmont silver +bailey-Pr Cat 1 +bailey belmont silver				
24	HGS	2	A1120.6736G	+Panel,Fabric 4-Circ W/Com Pt Lc 67H 36W HF HF 7M 01 7M 01	\$ 626.00	\$ 170.90	\$ 341.80	72.700
				+inner tone light +inner tone light +bailey-Pr Cat 1 +bailey belmont silver +bailey-Pr Cat 1 +bailey belmont silver				
25	HGS	42	A1120.6742G	+Panel,Fabric 4-Circ W/Com Pt Lc 67H 42W HF HF 7M 01 7M 01	\$ 659.00	\$ 179.91	\$ 7,556.22	72.700
				+inner tone light +inner tone light +bailey-Pr Cat 1 +bailey belmont silver +bailey-Pr Cat 1 +bailey belmont silver				
26	HGS	1	A1120.6748G	+Panel,Fabric 4-Circ W/Com Pt Lc 67H 48W HF HF 7M 01 7M 01	\$ 694.00	\$ 189.46	\$ 189.46	72.700
				+inner tone light +inner tone light +bailey-Pr Cat 1 +bailey belmont silver +bailey-Pr Cat 1 +bailey belmont silver				
27	HGS	1	A1165.6724J	+Panel,Partial-Glazed No Pwr W/Rcp & Com Pt Lc 67H 24W TR clear HF HF 7M 01 7M 01	\$ 1,079.00	\$ 294.57	\$ 294.57	72.700
				+inner tone light +inner tone light +bailey-Pr Cat 1 +bailey belmont silver +bailey-Pr Cat 1 +bailey belmont silver				
28	HGS	29	A1165.6730J	+Panel,Partial-Glazed No Pwr W/Rcp & Com Pt Lc 67H 30W TR clear HF HF 7M 01 7M 01	\$ 1,109.00	\$ 302.76	\$ 8,780.04	72.700
				+inner tone light +inner tone light +bailey-Pr Cat 1 +bailey belmont silver +bailey-Pr Cat 1 +bailey belmont silver				

LEE CO. HENDRY ST. 2ND FLOOR
F2122.SP4

Item	Cat	Qty	Part Number	Part Description	List \$	Sell \$	Ext Sell \$	Sell- %
29	HGS	99	A1165.6736J	+Panel,Partial-Glazed No Pwr W/Rcp & Com Pt Lc 67H 36W +clear +inner tone light +inner tone light +bailey-Pr Cat 1 +bailey belmont silver +bailey-Pr Cat 1 +bailey belmont silver	\$ 1,139.00	\$ 310.95	\$ 30,784.05	72.700
			TR					
			HF					
			HF					
			7M					
			01					
			7M					
			01					
30	HGS	4	A1165.6748J	+Panel,Partial-Glazed No Pwr W/Rcp & Com Pt Lc 67H 48W +clear +inner tone light +inner tone light +bailey-Pr Cat 1 +bailey belmont silver +bailey-Pr Cat 1 +bailey belmont silver	\$ 1,217.00	\$ 332.24	\$ 1,328.96	72.700
			TR					
			HF					
			HF					
			7M					
			01					
			7M					
			01					
31	HGS	68	A1220.67H	+Conn,2-Way 90 Deg Hard 67H +inner tone light +inner tone light	\$ 107.00	\$ 29.21	\$ 1,986.28	72.700
			HF					
			HF					
32	HGS	46	A1230.67H	+Conn,3-Way 90 Deg Hard 67H +inner tone light +inner tone light	\$ 191.00	\$ 52.14	\$ 2,398.44	72.700
			HF					
			HF					
33	HGS	24	A1240.67H	+Conn,4-Way 90 Deg 67H +inner tone light	\$ 247.00	\$ 67.43	\$ 1,618.32	72.700
			HF					
34	HGS	1	A1250.39H	+Fin End 39H +inner tone light +inner tone light	\$ 35.00	\$ 9.56	\$ 9.56	72.700
			HF					
			HF					
35	HGS	106	A1250.47H	+Fin End 47H +inner tone light +inner tone light	\$ 38.00	\$ 10.37	\$ 1,099.22	72.700
			HF					
			HF					
36	HGS	27	A1250.67H	+Fin End 67H +inner tone light +inner tone light	\$ 40.00	\$ 10.92	\$ 294.84	72.700
			HF					
			HF					
37	HGS	1	A1260.67H	+Spacer Hard 67H +inner tone light +inner tone light	\$ 125.00	\$ 34.13	\$ 34.13	72.700
			HF					
			HF					
38	HGS	14	A1311.A	+Duplex Rcp,4-Circ A 6/Pkg +inner tone light	\$ 151.00	\$ 41.22	\$ 577.08	72.700
			HF					
39	HGS	14	A1311.B	+Duplex Rcp,4-Circ B 6/Pkg +inner tone light	\$ 151.00	\$ 41.22	\$ 577.08	72.700
			HF					
40	HGS	5	A1311.C	+Duplex Rcp,4-Circ C 6/Pkg +inner tone light	\$ 151.00	\$ 41.22	\$ 206.10	72.700
			HF					
41	HGS	14	A1311.D	+Duplex Rcp,4-Circ D Dedicated 6/Pkg +inner tone light	\$ 151.00	\$ 41.22	\$ 577.08	72.700
			HF					
42	HGS	23	A1322.06E	+Base Pwr Entry,Dir Con 4-Circ,6Ft L +kale +inner tone light	\$ 120.00	\$ 32.76	\$ 753.48	72.700
			8X					
			HF					
43	HGS	1	A1355.30E	+Base Pwr Adapter,W/O Covers 4-Circ 30W +kale +inner tone light	\$ 123.00	\$ 33.58	\$ 33.58	72.700
			8X					
			HF					
44	HGS	1	A1355.36E	+Base Pwr Adapter,W/O Covers 4-Circ 36W +kale +inner tone light	\$ 123.00	\$ 33.58	\$ 33.58	72.700
			8X					
			HF					
45	HGS	1	A2310.2424L	+Work Surf,Sq-Edge Rect Lam 24D 24W +kale +inner tone light	\$ 219.00	\$ 59.79	\$ 59.79	72.700
			8X					
			HF					
46	HGS	3	A2310.2442L	+Work Surf,Sq-Edge Rect Lam 24D 42W +kale +inner tone light	\$ 298.00	\$ 81.35	\$ 244.05	72.700
			8X					
			HF					
47	HGS	28	A2310.2460L	+Work Surf,Sq-Edge Rect Lam 24D 60W +kale +inner tone light	\$ 402.00	\$ 109.75	\$ 3,073.00	72.700
			8X					
			HF					

LEE CO. HENDRY ST. 2ND FLOOR
F2122.SP4

Item	Cat	Qty	Part Number	Part Description	List \$	Sell \$	Ext Sell \$	Sell- %
48	HGS	45	A2310.2466L	+Work Surf,Sq-Edge Rect Lam 24D 66W +kale +inner tone light	\$ 428.00	\$ 116.84	\$ 5,257.80	72.700
49	HGS	2	A2310.2472L	+Work Surf,Sq-Edge Rect Lam 24D 72W +kale +inner tone light	\$ 472.00	\$ 128.86	\$ 257.72	72.700
50	HGS	1	A2310.2476L	+Work Surf,Sq-Edge Rect Lam 24D 76W +kale +inner tone light	\$ 492.00	\$ 134.32	\$ 134.32	72.700
51	HGS	2	A2310.2484L	+Work Surf,Sq-Edge Rect Lam 24D 84W +kale +inner tone light	\$ 531.00	\$ 144.96	\$ 289.92	72.700
52	HGS	23	A2310.2490L	+Work Surf,Sq-Edge Rect Lam 24D 90W +kale +inner tone light	\$ 588.00	\$ 160.52	\$ 3,691.96	72.700
53	HGS	2	A2310.2496L	+Work Surf,Sq-Edge Rect Lam 24D 96W +kale +inner tone light	\$ 633.00	\$ 172.81	\$ 345.62	72.700
54	HGS	72	A2310.3042L	+Work Surf,Sq-Edge Rect Lam 30D 42W +kale +inner tone light	\$ 373.00	\$ 101.83	\$ 7,331.76	72.700
55	HGS	6	A2310.3048L	+Work Surf,Sq-Edge Rect Lam 30D 48W +kale +inner tone light	\$ 388.00	\$ 105.92	\$ 635.52	72.700
56	HGS	1	A2310.3052L	+Work Surf,Sq-Edge Rect Lam 30D 52W +kale +inner tone light	\$ 434.00	\$ 118.48	\$ 118.48	72.700
57	HGS	1	A2310.3054L	+Work Surf,Sq-Edge Rect Lam 30D 54W +kale +inner tone light	\$ 455.00	\$ 124.22	\$ 124.22	72.700
58	HGS	3	A2310.3066L	+Work Surf,Sq-Edge Rect Lam 30D 66W +kale +inner tone light	\$ 533.00	\$ 145.51	\$ 436.53	72.700
59	HGS	4	A2310.3072L	+Work Surf,Sq-Edge Rect Lam 30D 72W +kale +inner tone light	\$ 588.00	\$ 160.52	\$ 642.08	72.700
60	HGS	2	A2310.3096L	+Work Surf,Sq-Edge Rect Lam 30D 96W +kale +inner tone light	\$ 752.00	\$ 205.30	\$ 410.60	72.700
61	HGS	4	A2380.24L	+Support Panel,Wk Surf,End Lam 24D +inner tone light	\$ 237.00	\$ 64.70	\$ 258.80	72.700
62	HGS	2	A2380.30L	+Support Panel,Wk Surf,End Lam 30D +inner tone light	\$ 268.00	\$ 73.16	\$ 146.32	72.700
63	HGS	1	A2381.29	+C-Leg +inner tone light	\$ 267.00	\$ 72.89	\$ 72.89	72.700
64	HGS	1	A2391.L	+Corner Wedge 16W +kale	\$ 88.00	\$ 24.02	\$ 24.02	72.700
65	HGS	1	A3210.1624	+Shelf,B-Style (EDP) 15-1/2H 16D 24W +inner tone light TAG: AISLE	\$ 148.00	\$ 40.40	\$ 40.40	72.700
66	HGS	2	A3210.1630	+Shelf,B-Style (EDP) 15-1/2H 16D 30W +inner tone light TAG: AISLE	\$ 161.00	\$ 43.95	\$ 87.90	72.700
67	HGS	1	A3210.1636	+Shelf,B-Style (EDP) 15-1/2H 16D 36W +inner tone light TAG: AISLE	\$ 185.00	\$ 50.51	\$ 50.51	72.700

LEE CO. HENDRY ST. 2ND FLOOR
F2122.SP4

Item	Cat	Qty	Part Number	Part Description	List \$	Sell \$	Ext Sell \$	Sell- %
68	HGS	100	A3221.1324	+Shelf,B-Style 7-1/2H 13D 24W	\$ 97.00	\$ 26.48	\$ 2,648.00	72.700
			HF	+inner tone light				
69	HGS	8	A3221.1330	+Shelf,B-Style 7-1/2H 13D 30W	\$ 102.00	\$ 27.85	\$ 222.80	72.700
			HF	+inner tone light				
70	HGS	1	A3221.1342	+Shelf,B-Style 7-1/2H 13D 42W	\$ 117.00	\$ 31.94	\$ 31.94	72.700
			HF	+inner tone light				
71	HGS	2	A3352.1324	+Flip Dr Unit,B-Style Fab,W/Lock 13D 24W 15-1/2H	\$ 387.00	\$ 105.65	\$ 211.30	72.700
			KD	+keyed differently				
			HF	+inner tone light				
			6B	+comet-Pr Cat 4				
			08	+comet winter solstice				
72	HGS	3	A3352.1330	+Flip Dr Unit,B-Style Fab,W/Lock 13D 30W 15-1/2H	\$ 406.00	\$ 110.84	\$ 332.52	72.700
			KD	+keyed differently				
			HF	+inner tone light				
			6B	+comet-Pr Cat 4				
			08	+comet winter solstice				
73	HGS	2	A3352.1336	+Flip Dr Unit,B-Style Fab,W/Lock 13D 36W 15-1/2H	\$ 434.00	\$ 118.48	\$ 236.96	72.700
			KD	+keyed differently				
			HF	+inner tone light				
			6B	+comet-Pr Cat 4				
			08	+comet winter solstice				
74	HGS	75	A3352.1342	+Flip Dr Unit,B-Style Fab,W/Lock 13D 42W 15-1/2H	\$ 463.00	\$ 126.40	\$ 9,480.00	72.700
			KD	+keyed differently				
			HF	+inner tone light				
			6B	+comet-Pr Cat 4				
			08	+comet winter solstice				
75	HGS	4	A3352.1348	+Flip Dr Unit,B-Style Fab,W/Lock 13D 48W 15-1/2H	\$ 486.00	\$ 132.68	\$ 530.72	72.700
			KD	+keyed differently				
			HF	+inner tone light				
			6B	+comet-Pr Cat 4				
			08	+comet winter solstice				
76	HGS	4	A3410.1624	+Tackboard,B-Style 16H 24W	\$ 196.00	\$ 53.51	\$ 214.04	72.700
			64	+flannel-Pr Cat 4				
			24	+flannel grape				
77	HGS	3	A3410.1630	+Tackboard,B-Style 16H 30W	\$ 202.00	\$ 55.15	\$ 165.45	72.700
			64	+flannel-Pr Cat 4				
			24	+flannel grape				
78	HGS	3	A3410.1636	+Tackboard,B-Style 16H 36W	\$ 211.00	\$ 57.60	\$ 172.80	72.700
			64	+flannel-Pr Cat 4				
			24	+flannel grape				
79	HGS	76	A3410.1642	+Tackboard,B-Style 16H 42W	\$ 218.00	\$ 59.51	\$ 4,522.76	72.700
			64	+flannel-Pr Cat 4				
			24	+flannel grape				
80	HGS	4	A3410.1648	+Tackboard,B-Style 16H 48W	\$ 227.00	\$ 61.97	\$ 247.88	72.700
			64	+flannel-Pr Cat 4				
			24	+flannel grape				
81	HGS	97	A3615.1624	+Tile,Rail Action Office® Series 2 24W	\$ 141.00	\$ 38.49	\$ 3,733.53	72.700
			HF	+inner tone light				
82	HGS	10	A3615.1630	+Tile,Rail Action Office® Series 2 30W	\$ 156.00	\$ 42.59	\$ 425.90	72.700
			HF	+inner tone light				
83	HGS	1	A3615.1636	+Tile,Rail Action Office® Series 2 36W	\$ 169.00	\$ 46.14	\$ 46.14	72.700
			HF	+inner tone light				
84	HGS	1	A4111.2436L	+Table,Sq-Edge Lam 24D 36W 29H	\$ 591.00	\$ 161.34	\$ 161.34	72.700
			8X	+kale				
			HF	+inner tone light				
85	HGS	3	A4111.2472L	+Table,Sq-Edge Lam 24D 72W 29H	\$ 686.00	\$ 187.28	\$ 561.84	72.700
			8X	+kale				
			HF	+inner tone light				

LEE CO. HENDRY ST. 2ND FLOOR
F2122.SP4

Item	Cat	Qty	Part Number	Part Description	List \$	Sell \$	Ext Sell \$	Sell- %
86	HGS	1	A4111.3048L	+Table,Sq-Edge Lam 30D 48W 29H	\$ 649.00	\$ 177.18	\$ 177.18	72.700
			8X	+kale				
			HF	+inner tone light				
87	MSC	35	AD10PB	*Side Chair,Stk,Aside,Nonuphol Outer Back	\$ 303.00	\$ 145.44	\$ 5,090.40	52.000
			MA	*metal arms				
			SG	*glide				
			MT	*medium tone				
			32	*iota™-Pr Cat 3				
			12	*iota™ marsh ice				
88	HGS	16	AO210.62	+Wall Start 62H	\$ 35.00	\$ 9.56	\$ 152.96	72.700
			HF	+inner tone light				
89	HGS	2	AO215.34	+Draw Rod 34H	\$ 15.00	\$ 4.10	\$ 8.20	72.700
90	HGS	215	AO215.62	+Draw Rod 62H	\$ 16.00	\$ 4.37	\$ 939.55	72.700
91	HGS	115	AO259.	+Fin End,Chg-Of-Ht,Panel/Conn	\$ 17.00	\$ 4.64	\$ 533.60	72.700
			HF	+inner tone light				
92	HGC	103	EE123AB	+Chair,Ergon 3 Pneu,Adj Arms,Knee Tilt Fwd Ang,Sz B	\$ 963.00	\$ 311.34	\$ 32,068.02	67.670
			N4	+not adjustable				
			MT	+medium tone				
			BC	+2" hd dbl wl caster, carpet				
			U6	+nonupholstered				
			MT	+medium tone				
			32	+iota™-Pr Cat 3				
			12	+iota™ marsh ice				
93	HGN	4	ET114L	+Table,Square Contract Base Lam Top 28.5H 42W	\$ 540.00	\$ 147.42	\$ 589.68	72.700
			8X	+kale				
			MT	+medium tone				
			MT	+medium tone				
			MT	+medium tone				
				TAG: BREAK ROOM				
94	HGN	1	ET156L	+Table,Oval Seg Base Vin Edge/Lam Top 28.5H 54D 96W	\$ 2,390.00	\$ 652.47	\$ 652.47	72.700
			7X	+cardamom				
			MT	+medium tone				
			MT	+medium tone				
			MT	+medium tone				
				TAG: CONFERENCE				
95	HGN	1	ET158L	+Table,Oval Seg Base Vin Edg/Lam Top 28.5H 54D 120W	\$ 3,460.00	\$ 944.58	\$ 944.58	72.700
			7X	+cardamom				
			MT	+medium tone				
			MT	+medium tone				
			MT	+medium tone				
				TAG: CONFERENCE				
96	HGN	1	ET187L	+Table,Rect Seg Base Vin Edg/Lam Top 28.5H 30D 60W	\$ 1,200.00	\$ 327.60	\$ 327.60	72.700
			8X	+kale				
			MT	+medium tone				
			MT	+medium tone				
			MT	+medium tone				
				TAG: LIBRARY 208				
97	MER	85	F16-1822-BBF	+Freestanding Ped Std Pull 18W 22D 26-1/4H (BBF)	\$ 630.00	\$ 241.79	\$ 20,552.15	61.620
			TS	+Textured Steel				
			HF	+inner tone Light non-metallic				
			T2	+Square Metal Top 1-1/4				
			KD	+Black - Keyed Differently				
			B2	+Base 1-1/2				
			CB	+Counterweight(recommended)				
			C	+Std. Compressor				
98	MER	79	F16-1822-FF	+Freestanding Ped Std Pull 18W 22D 26-1/4H (FF)	\$ 609.00	\$ 233.73	\$ 18,464.67	61.620
			TS	+Textured Steel				
			HF	+inner tone Light non-metallic				
			T2	+Square Metal Top 1-1/4				
			KD	+Black - Keyed Differently				
			B2	+Base 1-1/2				
			CB	+Counterweight(recommended)				
			C	+Std. Compressor				

LEE CO. HENDRY ST. 2ND FLOOR
F2122.SP4

Item	Cat	Qty	Part Number	Part Description	List \$	Sell \$	Ext Sell \$	Sell- %	
99	HGS	83	G5010. HF	+Drw,Pencil 21W 16D +inner tone light	\$ 42.00	\$ 11.47	\$ 952.01	72.700	
100	HGS	102	G6120.24MEN HF	+Task Light,E.E. Electronic Ballast/No Dimmer 24W +inner tone light	\$ 210.00	\$ 57.33	\$ 5,847.66	72.700	
101	HGS	11	G6120.30MEN HF	+Task Light,E.E. Electronic Ballast/No Dimmer 30W +inner tone light	\$ 218.00	\$ 59.51	\$ 654.61	72.700	
102	HGS	3	G6120.36MEN HF	+Task Light,E.E. Electronic Ballast/No Dimmer 36W +inner tone light	\$ 224.00	\$ 61.15	\$ 183.45	72.700	
103	HGS	76	G6120.42MEN HF	+Task Light,E.E. Electronic Ballast/No Dimmer 42W +inner tone light	\$ 234.00	\$ 63.88	\$ 4,854.88	72.700	
104	HGS	4	G6120.48MEN HF	+Task Light,E.E. Electronic Ballast/No Dimmer 48W +inner tone light	\$ 239.00	\$ 65.25	\$ 261.00	72.700	
105	HGS	200	G7110.10 HF	+Paper Tray 10W +inner tone light	\$ 32.00	\$ 8.74	\$ 1,748.00	72.700	
106	HGS	200	G7130. HF	+Diag Tray +inner tone light	\$ 51.00	\$ 13.92	\$ 2,784.00	72.700	
107	HGS	27	G7715.04K HF	+Keybd Tray,Fully Adj,Std-Length Arm,Knob Adj +inner tone light	\$ 356.00	\$ 97.19	\$ 2,624.13	72.700	
108	HGS	27	G7742.	+Mouse Tray,Wk Surf Att,Adj/Storable	\$ 206.00	\$ 56.24	\$ 1,518.48	72.700	
109	GR3	4	3503S-1-E G4-03 CRE-55	GROUP 4 CONTINUUM SERIES CHAIR (SPLIT SEAT & BACK) EPOXY FRAME ANTIQUUE WHITE EPOXY FRAME OLYMPIAD VINYLs CRETE CURRANT	\$ 612.00	\$ 287.64	\$ 1,150.56	53.000	
110	GR3	12	3503S-4-E G4-03 CRE-55	GROUP 4 CONTINUUM SERIES LINK CHAIR (SPLIT SEAT & BACK) EPOXY FRAME ANTIQUUE WHITE EPOXY FRAME OLYMPIAD VINYLs CRETE CURRANT	\$ 590.00	\$ 277.30	\$ 3,327.60	53.000	
111	GR3	4	3503-5-E G4-03 4634 G4-03	GROUP 4 CONTINUUM SERIES LINK END TABLE EPOXY FRAME, PVC EDGE ANTIQUUE WHITE EPOXY FRAME STORM NEBULA ANTIQUUE WHITE PVC EDGE	\$ 350.00	\$ 164.50	\$ 658.00	53.000	
112	BR6	2	PPCLD34L 050 QZ Q	BRETFORD LOADED PRESENTATION CABINET WITH TOOL CUBBY, RIGHT SIDE FLIP CHART HOLDER AND SCREEN, LAMINATE, 48"H X 48"W X 3"D GREY QUARTZ LAMINATE QUARTZ BASE COLOR QUARTZ-TRIM COLOR	\$ 2,047.00	\$ 1,207.73	\$ 2,415.46	41.000	
113	BPE	2	PMT7644 QZ 1 1 050 Q	Media Tower, 77H x 32D x 45W Quartz Laminate w/ 3mm PVC Edge Solid Laminate Grey Quartz	\$ 4,453.00	\$ 2,627.27	\$ 5,254.54	41.000	
114	HGC	16	WC410P MS EM U5 SY	+Chair,Caper® Multipurpose Stacking,Molded Seat,Fixed Arms +metallic silver +evergreen +soft wheel caster, carpet or hard floors +silver grey TAG: BREAK ROOM	\$ 275.00	\$ 108.32	\$ 1,733.12	60.610	
115	GU1	1	SUBC-INSTALLAT ION	TO RECEIVE, DELIVER AND INSTALL PRODUCT	\$ 56,850.01	\$ 56,850.00	\$ 56,850.00	0.000	
116	GU1	153	SUBC-INSTALLAT ION	TO RECEIVE, DELIVER AND INSTALL SEATING PER STATE CONTRACT GUIDELINES	\$ 10.01	\$ 10.00	\$ 1,530.00	0.100	
117	GU1	3	SUBC-INSTALLAT ION	TO RECEIVE, DELIVER AND INSTALL TABLES PER STATE CONTRACT GUIDELINES	\$ 100.01	\$ 100.00	\$ 300.00	0.010	
118	651	1	DESIGN	DESIGN SERVICES UNDER SEPARATE CONTRACT SPEC ENTERED 3/7/03 REV. FOR FIELD DATA 4/11/03 REVISED 4/24/03	\$ 0.00	\$ 0.00	\$ 0.00	0.000	
							Grand Total	\$ 331,214.84	65.195

LEE CO. HENDRY ST. 3RD FLOOR: HUMAN RESOURCES
 F2984HR.SP4

Item	Cat	Qty	Part Number	Part Description	List \$	Sell \$	Ext Sell \$	Sell-%
1	MER	3	26-3620-5D	+File,FS Lat Std Pull,1 FD/4 Dwr +textured steel +inner tone light +1 1/4"-high painted metal top with squared edge +keyed differently, black +1 1/2"-high base +counterweight (recommended) +side-to-side filing rail	\$ 1,540.00	\$ 521.14	\$ 1,563.42	66.160
			TS HF T2 KD B2 CB 9R					
2	MER	1	26-4220-2N	+File,FS Lat Std Pull,2 Dwr +textured steel +inner tone light +1 1/4"-high painted metal top with squared edge +keyed differently, black +1 1/2"-high base +counterweight (recommended) +front-to-back filing rail	\$ 841.00	\$ 284.59	\$ 284.59	66.160
			TS HF T2 KD B2 CB 9P					
3	MER	2	26-4220-5D	+File,FS Lat Std Pull,1 FD/4 Dwr +textured steel +inner tone light +1 1/4"-high painted metal top with squared edge +keyed differently, black +1 1/2"-high base +counterweight (recommended) +front-to-back filing rail	\$ 1,722.00	\$ 582.72	\$ 1,165.44	66.160
			TS HF T2 KD B2 CB 9P					
4	MER	2	46-3615-OB-55	+Bookcase Three Adjust Shelves 55-1/4H 36W 15D +Textured Steel +inner tone Light non-metallic +Standard Metal Top 1-1/4 +With Three Shelves +1-1/2in Base	\$ 568.00	\$ 212.26	\$ 424.52	62.630
			TS HF T2 NS3 B2					
5	HGS	1	A1120.3924C	+Panel,Fabric Npwr W/Rcp Lc 39H 24W +inner tone light +inner tone light +bailey-Pr Cat 1 +bailey belmont silver +bailey-Pr Cat 1 +bailey belmont silver	\$ 303.00	\$ 82.72	\$ 82.72	72.700
			HF HF 7M 01 7M 01					
6	HGS	5	A1120.3924E	+Panel,Fabric Pwr 4-Circ 39H 24W +inner tone light +inner tone light +bailey-Pr Cat 1 +bailey belmont silver +bailey-Pr Cat 1 +bailey belmont silver	\$ 426.00	\$ 116.30	\$ 581.50	72.700
			HF HF 7M 01 7M 01					
7	HGS	4	A1120.3930E	+Panel,Fabric Pwr 4-Circ 39H 30W +inner tone light +inner tone light +bailey-Pr Cat 1 +bailey belmont silver +bailey-Pr Cat 1 +bailey belmont silver	\$ 455.00	\$ 124.22	\$ 496.88	72.700
			HF HF 7M 01 7M 01					
8	HGS	1	A1120.3936C	+Panel,Fabric Npwr W/Rcp Lc 39H 36W +inner tone light +inner tone light +bailey-Pr Cat 1 +bailey belmont silver +bailey-Pr Cat 1 +bailey belmont silver	\$ 375.00	\$ 102.38	\$ 102.38	72.700
			HF HF 7M 01 7M 01					
9	HGS	2	A1120.3942E	+Panel,Fabric Pwr 4-Circ 39H 42W +inner tone light +inner tone light +bailey-Pr Cat 1 +bailey belmont silver +bailey-Pr Cat 1 +bailey belmont silver	\$ 519.00	\$ 141.69	\$ 283.38	72.700
			HF HF 7M 01 7M 01					

LEE CO. HENDRY ST. 3RD FLOOR: HUMAN RESOURCES
 F2984HR.SP4

Item	Cat	Qty	Part Number	Part Description	List \$	Sell \$	Ext Sell \$	Sell-%
10	HGS	1	A1120.3948E	+Panel,Fabric Pwr 4-Circ 39H 48W	\$ 539.00	\$ 147.15	\$ 147.15	72.700
			HF	+inner tone light				
			HF	+inner tone light				
			7M	+bailey-Pr Cat 1				
			01	+bailey belmont silver				
			7M	+bailey-Pr Cat 1				
			01	+bailey belmont silver				
11	HGS	8	A1120.6724E	+Panel,Fabric Pwr 4-Circ 67H 24W	\$ 505.00	\$ 137.87	\$ 1,102.96	72.700
			HF	+inner tone light				
			HF	+inner tone light				
			7M	+bailey-Pr Cat 1				
			01	+bailey belmont silver				
			7M	+bailey-Pr Cat 1				
			01	+bailey belmont silver				
12	HGS	6	A1120.6730E	+Panel,Fabric Pwr 4-Circ 67H 30W	\$ 552.00	\$ 150.70	\$ 904.20	72.700
			HF	+inner tone light				
			HF	+inner tone light				
			7M	+bailey-Pr Cat 1				
			01	+bailey belmont silver				
			7M	+bailey-Pr Cat 1				
			01	+bailey belmont silver				
13	HGS	5	A1120.6736E	+Panel,Fabric Pwr 4-Circ 67H 36W	\$ 620.00	\$ 169.26	\$ 846.30	72.700
			HF	+inner tone light				
			HF	+inner tone light				
			7M	+bailey-Pr Cat 1				
			01	+bailey belmont silver				
			7M	+bailey-Pr Cat 1				
			01	+bailey belmont silver				
14	HGS	1	A1120.6742E	+Panel,Fabric Pwr 4-Circ 67H 42W	\$ 653.00	\$ 178.27	\$ 178.27	72.700
			HF	+inner tone light				
			HF	+inner tone light				
			7M	+bailey-Pr Cat 1				
			01	+bailey belmont silver				
			7M	+bailey-Pr Cat 1				
			01	+bailey belmont silver				
15	HGS	5	A1120.6748E	+Panel,Fabric Pwr 4-Circ 67H 48W	\$ 688.00	\$ 187.82	\$ 939.10	72.700
			HF	+inner tone light				
			HF	+inner tone light				
			7M	+bailey-Pr Cat 1				
			01	+bailey belmont silver				
			7M	+bailey-Pr Cat 1				
			01	+bailey belmont silver				
16	HA2	1	A1165.6730C	+Panel,Partial-Glazed Npwr W/Rcp Lc 67H 30W	\$ 1,103.00	\$ 301.12	\$ 301.12	72.700
			TR	+clear				
			HF	+inner tone light				
			HF	+inner tone light				
			7M	+bailey-Pr Cat 1				
			01	+bailey belmont silver				
			7M	+bailey-Pr Cat 1				
			01	+bailey belmont silver				
17	HGS	1	A1220.39H	+Conn,2-Way 90 Deg Hard 39H	\$ 84.00	\$ 22.93	\$ 22.93	72.700
			HF	+inner tone light				
			HF	+inner tone light				
18	HGS	13	A1220.67H	+Conn,2-Way 90 Deg Hard 67H	\$ 107.00	\$ 29.21	\$ 379.73	72.700
			HF	+inner tone light				
			HF	+inner tone light				
19	HGS	1	A1230.67H	+Conn,3-Way 90 Deg Hard 67H	\$ 191.00	\$ 52.14	\$ 52.14	72.700
			HF	+inner tone light				
			HF	+inner tone light				
20	HGS	5	A1250.39H	+Fin End 39H	\$ 35.00	\$ 9.56	\$ 47.80	72.700
			HF	+inner tone light				
			HF	+inner tone light				
21	HGS	4	A1250.67H	+Fin End 67H	\$ 40.00	\$ 10.92	\$ 43.68	72.700
			HF	+inner tone light				
			HF	+inner tone light				

LEE CO. HENDRY ST. 3RD FLOOR: HUMAN RESOURCES
F2984HR.SP4

Item	Cat	Qty	Part Number	Part Description	List \$	Sell \$	Ext Sell \$	Sell-%
22	HGS	1	A1311.A	+Duplex Rcp,4-Circ A 6/Pkg	\$ 151.00	\$ 41.22	\$ 41.22	72.700
			HF	+inner tone light				
23	HGS	1	A1311.B	+Duplex Rcp,4-Circ B 6/Pkg	\$ 151.00	\$ 41.22	\$ 41.22	72.700
			HF	+inner tone light				
24	HGS	1	A1311.C	+Duplex Rcp,4-Circ C 6/Pkg	\$ 151.00	\$ 41.22	\$ 41.22	72.700
			HF	+inner tone light				
25	HGS	1	A1311.D	+Duplex Rcp,4-Circ D Dedicated 6/Pkg	\$ 151.00	\$ 41.22	\$ 41.22	72.700
			HF	+inner tone light				
26	HGS	4	A1322.06E	+Base Pwr Entry,Dir Con 4-Circ,6Fl L	\$ 120.00	\$ 32.76	\$ 131.04	72.700
27	HGS	3	A2310.2442L	+Work Surf,Sq-Edge Rect Lam 24D 42W	\$ 298.00	\$ 81.35	\$ 244.05	72.700
			8X	+kale				
			HF	+inner tone light				
28	HGS	2	A2310.2460L	+Work Surf,Sq-Edge Rect Lam 24D 60W	\$ 402.00	\$ 109.75	\$ 219.50	72.700
			8X	+kale				
			HF	+inner tone light				
29	HGS	4	A2310.2472L	+Work Surf,Sq-Edge Rect Lam 24D 72W	\$ 472.00	\$ 128.86	\$ 515.44	72.700
			8X	+kale				
			HF	+inner tone light				
30	HGS	3	A2310.3072L	+Work Surf,Sq-Edge Rect Lam 30D 72W	\$ 588.00	\$ 160.52	\$ 481.56	72.700
			8X	+kale				
			HF	+inner tone light				
31	HGS	3	A2380.30L	+Support Panel,Wk Surf,End Lam 30D	\$ 268.00	\$ 73.16	\$ 219.48	72.700
			HF	+inner tone light				
			HF	+inner tone light				
32	HGS	1	A3221.1324	+Shelf,B-Style 7-1/2H 13D 24W	\$ 97.00	\$ 26.48	\$ 26.48	72.700
			HF	+inner tone light				
33	HGS	3	A3352.1324	+Flip Dr Unit,B-Style Fab,W/Lock 13D 24W 15-1/2H	\$ 387.00	\$ 105.65	\$ 316.95	72.700
			KD	+keyed differently				
			HF	+inner tone light				
			6B	+comet-Pr Cat 4				
			08	+Comet-Winter Solstice				
34	HGS	5	A3352.1330	+Flip Dr Unit,B-Style Fab,W/Lock 13D 30W 15-1/2H	\$ 406.00	\$ 110.84	\$ 554.20	72.700
			KD	+keyed differently				
			HF	+inner tone light				
			6B	+comet-Pr Cat 4				
			08	+Comet-Winter Solstice				
35	HGS	1	A3352.1342	+Flip Dr Unit,B-Style Fab,W/Lock 13D 42W 15-1/2H	\$ 463.00	\$ 126.40	\$ 126.40	72.700
			KD	+keyed differently				
			HF	+inner tone light				
			6B	+comet-Pr Cat 4				
			08	+Comet-Winter Solstice				
36	HGS	3	A3352.1348	+Flip Dr Unit,B-Style Fab,W/Lock 13D 48W 15-1/2H	\$ 486.00	\$ 132.68	\$ 398.04	72.700
			KD	+keyed differently				
			HF	+inner tone light				
			6B	+comet-Pr Cat 4				
			08	+Comet-Winter Solstice				
37	HGS	3	A3410.1248	+Tackboard,B-Style 12H 48W	\$ 174.00	\$ 47.50	\$ 142.50	72.700
			64	+flannel-Pr Cat 4				
			24	+flannel grape				
38	HGS	1	A3610.48	+Tool Bar,B-Style 4H 48W	\$ 83.00	\$ 22.66	\$ 22.66	72.700
			HF	+inner tone light				
39	HAO	1	A3615.1630	+Tile,Rail Action Office® Series 2 30W	\$ 156.00	\$ 42.59	\$ 42.59	72.700
			HF	+inner tone light				
40	HAO	2	A3615.1648	+Tile,Rail Action Office® Series 2 48W	\$ 198.00	\$ 54.05	\$ 108.10	72.700
			HF	+inner tone light				

LEE CO. HENDRY ST. 3RD FLOOR: HUMAN RESOURCES
F2984HR.SP4

Item	Cat	Qty	Part Number	Part Description	List \$	Sell \$	Ext Sell \$	Sell- %
41	HST	8	AD10UB	+Side Chair,Slk,Aside,Uphol Outer Back	\$ 322.00	\$ 154.56	\$ 1,236.48	52.000
			MA	+metal arms				
			SG	+glide				
			MS	+metallic silver				
			32	+iota™-Pr Cat 3				
			12	+iota™ marsh ice				
42	HGS	6	AO215.34	+Draw Rod 34H	\$ 15.00	\$ 4.10	\$ 24.60	72.700
43	HGS	14	AO215.62	+Draw Rod 62H	\$ 16.00	\$ 4.37	\$ 61.18	72.700
44	HGS	9	AO259.	+Fin End,Chg-Of-Ht,Panel/Conn	\$ 17.00	\$ 4.64	\$ 41.76	72.700
			HF	+inner tone light				
45	HGC	4	EE122AB	+Chair,Ergon 3 Pneu,Adj Arms,Knee Tilt,Sz B	\$ 1,048.00	\$ 338.82	\$ 1,355.28	67.670
			AJ	+adjustable				
			MT	+medium tone				
			BC	+2" hd dbl wl caster, carpet				
			U6	+nonupholstered				
			MT	+medium tone				
			32	+iota™-Pr Cat 3				
			12	+iota™ marsh ice				
46	MER	1	F16-1518-BBF	+Freestanding Ped Std Pull 15W 18D 26-1/4H (BBF)	\$ 639.00	\$ 245.25	\$ 245.25	61.620
			TS	+Textured Steel				
			1209	+platinum metallic				
			T2	+Square Metal Top 1-1/4				
			KD	+Black - Keyed Differently				
			BC	+Rec Base 2-1/4				
			CB	+Counterweight(recommended)				
			C	+Std. Compressor				
47	MER	1	F16-1518-FF	+Freestanding Ped Std Pull 15W 18D 26-1/4H (FF)	\$ 617.00	\$ 236.80	\$ 236.80	61.620
			TS	+Textured Steel				
			1209	+platinum metallic				
			T2	+Square Metal Top 1-1/4				
			KD	+Black - Keyed Differently				
			BC	+Rec Base 2-1/4				
			CB	+Counterweight(recommended)				
			C	+Std. Compressor				
48	HGS	4	G5010.	+Drw,Pencil 21W 16D	\$ 42.00	\$ 11.47	\$ 45.88	72.700
			HF	+inner tone light				
49	HGS	3	G5120.19	+Ped,B-Frt Stationary 6,6,12 27H 20D 15W	\$ 670.00	\$ 182.91	\$ 548.73	72.700
			HF	+inner tone light				
			KD	+keyed differently				
50	HGS	3	G5130.19	+Ped,B-Frt Stationary 12,12 27H 20D 15W	\$ 645.00	\$ 176.09	\$ 528.27	72.700
			HF	+inner tone light				
			KD	+keyed differently				
51	HGS	3	G6120.24MEN	+Task Light,E.E. Electronic Ballast/No Dimmer 24W	\$ 200.00	\$ 54.60	\$ 163.80	72.700
			HF	+inner tone light				
52	HGS	5	G6120.30MEN	+Task Light,E.E. Electronic Ballast/No Dimmer 30W	\$ 218.00	\$ 59.51	\$ 297.55	72.700
			HF	+inner tone light				
53	HGS	1	G6120.42MEN	+Task Light,E.E. Electronic Ballast/No Dimmer 42W	\$ 234.00	\$ 63.88	\$ 63.88	72.700
			HF	+inner tone light				
54	HGS	2	G6120.48MEN	+Task Light,E.E. Electronic Ballast/No Dimmer 48W	\$ 239.00	\$ 65.25	\$ 130.50	72.700
			HF	+inner tone light				
55	HGS	2	G7000.29	+Tool Rail,Wk Surf Att,29W	\$ 265.00	\$ 72.35	\$ 144.70	72.700
			MS	+metallic silver				
56	HGS	1	G7311.27F	+Shelf,Wk Surf Att,27W	\$ 465.00	\$ 126.95	\$ 126.95	72.700
			MS	+metallic silver				
			4G	+raisin				
57	HGS	8	G7110.10	+Paper Tray 10W	\$ 32.00	\$ 8.74	\$ 69.92	72.700
			HF	+inner tone light				
58	HGS	8	G7130.	+Diag Tray	\$ 51.00	\$ 13.92	\$ 111.36	72.700
			HF	+inner tone light				

LEE CO. HENDRY ST. 3RD FLOOR: HUMAN RESOURCES
 F2984HR.SP4

Item	Cat	Qty	Part Number	Part Description	List \$	Sell \$	Ext Sell \$	Sell-%
59	HGS	3	G7715.04K	+Keybd Tray,Fully Adj,Std-Length Arm,Knob Adj	\$ 356.00	\$ 97.19	\$ 291.57	72.700
			MT	+medium tone				
60	HGS	3	G7742.	+Mouse Tray,Wk Surf Att,Adj/Storable	\$ 206.00	\$ 56.24	\$ 168.72	72.700
61	HPS	1	PB1LC.DD24N	+Rec,Lam Top/Vin Ed,L Rec Leg/R Full End,Nonpwr	\$ 830.00	\$ 368.85	\$ 368.85	55.560
			1209	+platinum				
			8X	+kale				
			G2	+graphite satin				
			-	+specification complete				
62	HPS	1	PB1LC.DE42N	+Rec,24x48,Lam Top/Vin Ed,L Full End/R Rec	\$ 855.00	\$ 379.96	\$ 379.96	55.560
			1209	Leg,Nonpwr				
			1209	+platinum				
			8X	+kale				
			G2	+graphite satin				
			-	+specification complete				
63	HPS	1	PB1LE.DC32N	+Rec,24x36,Lam Top/Vin Ed,L C-Leg/R Rec Leg,Nonpwr	\$ 775.00	\$ 344.41	\$ 344.41	55.560
			1209	+platinum				
			8X	+kale				
			G2	+graphite satin				
			-	+specification complete				
64	HPS	1	PC3LE.HC24N	+Obi Pen,24x90,Lam Top/Vin Ed,L Rec Leg/R Full	\$ 2,045.00	\$ 908.80	\$ 908.80	55.560
			1209	End,Nonpwr				
			1209	+platinum				
			8X	+kale				
			G2	+graphite satin				
			MP	+24" modesty panel				
			-	+specification complete				
65	HPS	1	PE131.3048L	+Mobi Tbl,D-Shape,Adj Hl,Lam Top/Vin Ed,30Dx48W	\$ 940.00	\$ 417.74	\$ 417.74	55.560
			1209	+platinum				
			8X	+kale				
			G2	+graphite satin				
66	NT1	1	OP-S2120	OCCASIONAL TABLE HPL - CUBE	\$ 385.00	\$ 152.46	\$ 152.46	60.400
			440	CLOUD				
67	GU1	12	SUBC-INSTALLATION	TO RECEIVE, DELIVER AND INSTALL SEATING PER	\$ 15.01	\$ 15.00	\$ 180.00	0.067
				STATE OF FLORIDA CONTRACT GUIDELINES				
68	GU1	1	SUBC-INSTALLATION	TO RECEIVE, DELIVER AND INSTALL PRODUCT	\$ 3,800.01	\$ 3,800.00	\$ 3,800.00	0.000
69	65I	40	DESIGN	DESIGN SERVICES	\$ 55.01	\$ 55.00	\$ 2,200.00	0.018
				SPEC ENTERED 2/5/03				
				REVISED 2/19/03				
				REVISED 5/7/03				
				Grand Total			\$ 28,309.48	63.641

LEE CO. HENDRY ST. 3RD FL: INTERNAL AUDIT
 F2984INTAUDITREV.SP4

Item	Cat	Qty	Part Number	Part Description	List \$	Sell \$	Ext Sell \$	Sell- %
1	MER	1	26-3020-2N	+File,FS Lat Std Pull,2 Dwr +textured steel +inner tone light +1 1/4"-high painted metal top with squared edge +keyed differently, black +1 1/2"-high base +counterweight (recommended) +front-to-back filing rail	\$ 690.00	\$ 233.50	\$ 233.50	66.160
			TS HF T2 KD B2 CB 9P					
2	MER	11	26-3620-2N	+File,FS Lat Std Pull,2 Dwr +textured steel +inner tone light +1 1/4"-high painted metal top with squared edge +keyed differently, black +1 1/2"-high base +counterweight (recommended) Skipped Option	\$ 755.00	\$ 255.49	\$ 2,810.39	66.160
			TS HF T2 KD B2 CB					
3	MER	1	46-3020-69	+Storage Case Std Pull 30W 20D 68-3/8H +Textured Steel +inner tone Light non-metallic +Four Shelves +Black - Keyed Differently +Square Edge Metal Top 1-1/4 +With Doors +1-1/2in Base	\$ 828.00	\$ 309.42	\$ 309.42	62.630
			TS HF NS4 KD T2 Y B2					
4	MER	3	46-3615-OB-42	+Bookcase Two Adjust Shelves 42-1/8H 36W 15D +Textured Steel +inner tone Light non-metallic +Standard Metal Top 1-1/4 +With Two Shelves +1-1/2in Base	\$ 542.00	\$ 202.55	\$ 607.65	62.630
			TS HF T2 NS2 B2					
5	HGS	1	A1120.3918E	+Panel,Fabric Pwr 4-Circ 39H 18W +inner tone light +inner tone light +bailey-Pr Cat 1 +bailey belmont silver +bailey-Pr Cat 1 +bailey belmont silver	\$ 423.00	\$ 115.48	\$ 115.48	72.700
			HF HF 7M 01 7M 01					
6	HGS	8	A1120.3924G	+Panel,Fabric 4-Circ W/Com Pt Lc 39H 24W +inner tone light +inner tone light +bailey-Pr Cat 1 +bailey belmont silver +bailey-Pr Cat 1 +bailey belmont silver	\$ 432.00	\$ 117.94	\$ 943.52	72.700
			HF HF 7M 01 7M 01					
7	HGS	6	A1120.3930G	+Panel,Fabric 4-Circ W/Com Pt Lc 39H 30W +inner tone light +inner tone light +bailey-Pr Cat 1 +bailey belmont silver +bailey-Pr Cat 1 +bailey belmont silver	\$ 461.00	\$ 125.85	\$ 755.10	72.700
			HF HF 7M 01 7M 01					
8	HGS	1	A1120.3936G	+Panel,Fabric 4-Circ W/Com Pt Lc 39H 36W +inner tone light +inner tone light +bailey-Pr Cat 1 +bailey belmont silver +bailey-Pr Cat 1 +bailey belmont silver	\$ 504.00	\$ 137.59	\$ 137.59	72.700
			HF HF 7M 01 7M 01					
9	HGS	4	A1120.3942G	+Panel,Fabric 4-Circ W/Com Pt Lc 39H 42W +inner tone light +inner tone light +bailey-Pr Cat 1 +bailey belmont silver +bailey-Pr Cat 1 +bailey belmont silver	\$ 525.00	\$ 143.33	\$ 573.32	72.700
			HF HF 7M 01 7M 01					
10	HGS	7	A1120.5324G	+Panel,Fabric 4-Circ W/Com Pt Lc 53H 24W +inner tone light +inner tone light +bailey-Pr Cat 1 +bailey belmont silver +bailey-Pr Cat 1 +bailey belmont silver	\$ 457.00	\$ 124.76	\$ 873.32	72.700
			HF HF 7M 01 7M 01					

LEE CO. HENDRY ST. 3RD FL: INTERNAL AUDIT
 F2984INTAUDITREV.SP4

Item	Cat	Qty	Part Number	Part Description	List \$	Sell \$	Ext Sell \$	Sell- %
11	HGS	14	A1120.5336G	+Panel,Fabric 4-Circ W/Com Pt Lc 53H 36W	\$ 566.00	\$ 154.52	\$ 2,163.28	72.700
			HF	+inner tone light				
			HF	+inner tone light				
			7M	+bailey-Pr Cat 1				
			01	+bailey belmont silver				
			7M	+bailey-Pr Cat 1				
			01	+bailey belmont silver				
12	HGS	11	A1120.5348G	+Panel,Fabric 4-Circ W/Com Pt Lc 53H 48W	\$ 632.00	\$ 172.54	\$ 1,897.94	72.700
			HF	+inner tone light				
			HF	+inner tone light				
			7M	+bailey-Pr Cat 1				
			01	+bailey belmont silver				
			7M	+bailey-Pr Cat 1				
			01	+bailey belmont silver				
13	HGS	1	A1120.6712E	+Panel,Fabric Pwr 4-Circ 67H 12W	\$ 449.00	\$ 122.58	\$ 122.58	72.700
			HF	+inner tone light				
			HF	+inner tone light				
			7M	+bailey-Pr Cat 1				
			01	+bailey belmont silver				
			7M	+bailey-Pr Cat 1				
			01	+bailey belmont silver				
14	HGS	8	A1120.6724G	+Panel,Fabric 4-Circ W/Com Pt Lc 67H 24W	\$ 511.00	\$ 139.50	\$ 1,116.00	72.700
			HF	+inner tone light				
			HF	+inner tone light				
			7M	+bailey-Pr Cat 1				
			01	+bailey belmont silver				
			7M	+bailey-Pr Cat 1				
			01	+bailey belmont silver				
15	HGS	6	A1120.6730G	+Panel,Fabric 4-Circ W/Com Pt Lc 67H 30W	\$ 558.00	\$ 152.33	\$ 913.98	72.700
			HF	+inner tone light				
			HF	+inner tone light				
			7M	+bailey-Pr Cat 1				
			01	+bailey belmont silver				
			7M	+bailey-Pr Cat 1				
			01	+bailey belmont silver				
16	HGS	4	A1120.6736G	+Panel,Fabric 4-Circ W/Com Pt Lc 67H 36W	\$ 626.00	\$ 170.90	\$ 683.60	72.700
			HF	+inner tone light				
			HF	+inner tone light				
			7M	+bailey-Pr Cat 1				
			01	+bailey belmont silver				
			7M	+bailey-Pr Cat 1				
			01	+bailey belmont silver				
17	HGS	4	A1120.6742G	+Panel,Fabric 4-Circ W/Com Pt Lc 67H 42W	\$ 659.00	\$ 179.91	\$ 719.64	72.700
			HF	+inner tone light				
			HF	+inner tone light				
			7M	+bailey-Pr Cat 1				
			01	+bailey belmont silver				
			7M	+bailey-Pr Cat 1				
			01	+bailey belmont silver				
18	HGS	2	A1120.6748G	+Panel,Fabric 4-Circ W/Com Pt Lc 67H 48W	\$ 694.00	\$ 189.46	\$ 378.92	72.700
			HF	+inner tone light				
			HF	+inner tone light				
			7M	+bailey-Pr Cat 1				
			01	+bailey belmont silver				
			7M	+bailey-Pr Cat 1				
			01	+bailey belmont silver				
19	HA2	10	A1165.5324J	+Panel,Partial-Glazed No Pwr W/Rcp & Com Pt Lc 53H 24W	\$ 1,001.00	\$ 273.27	\$ 2,732.70	72.700
			TR	+clear				
			HF	+inner tone light				
			HF	+inner tone light				
			7M	+bailey-Pr Cat 1				
			01	+bailey belmont silver				
			7M	+bailey-Pr Cat 1				
			01	+bailey belmont silver				
20	HA2	11	A1165.5330J	+Panel,Partial-Glazed No Pwr W/Rcp & Com Pt Lc 53H 30W	\$ 1,049.00	\$ 286.38	\$ 3,150.18	72.700
			TR	+clear				
			HF	+inner tone light				
			HF	+inner tone light				
			7M	+bailey-Pr Cat 1				
			01	+bailey belmont silver				
			7M	+bailey-Pr Cat 1				
			01	+bailey belmont silver				

LEE CO. HENDRY ST. 3RD FL: INTERNAL AUDIT
F2984INTAUDITREV.SP4

Item	Cat	Qty	Part Number	Part Description	List \$	Sell \$	Ext Sell \$	Sell- %
21	HA2	1	A1165.6736J	+Panel,Partial-Glazed No Pwr W/Rcp & Com Pt Lc 67H 36W +clear +inner tone light +inner tone light +bailey-Pr Cat 1 +bailey belmont silver +bailey-Pr Cat 1 +bailey belmont silver	\$ 1,139.00	\$ 310.95	\$ 310.95	72.700
			TR					
			HF					
			HF					
			7M					
			01					
			7M					
			01					
22	HCU	1	SA120735	A2-PANEL, FABRIC, NONPWR W/RECEPTACLE LOC, 53H, 42W	\$ 1,156.00	\$ 315.59	\$ 315.59	72.700
			SA120735					
23	HGS	6	A1220.53H	+Conn,2-Way 90 Deg Hard 53H	\$ 98.00	\$ 26.75	\$ 160.50	72.700
			HF	+inner tone light				
			HF	+inner tone light				
24	HGS	3	A1220.67H	+Conn,2-Way 90 Deg Hard 67H	\$ 107.00	\$ 29.21	\$ 87.63	72.700
			HF	+inner tone light				
			HF	+inner tone light				
25	HGS	13	A1230.53H	+Conn,3-Way 90 Deg Hard 53H	\$ 174.00	\$ 47.50	\$ 617.50	72.700
			HF	+inner tone light				
			HF	+inner tone light				
26	HGS	3	A1230.67H	+Conn,3-Way 90 Deg Hard 67H	\$ 191.00	\$ 52.14	\$ 156.42	72.700
			HF	+inner tone light				
			HF	+inner tone light				
27	HGS	4	A1250.39H	+Fin End 39H	\$ 35.00	\$ 9.56	\$ 38.24	72.700
			HF	+inner tone light				
			HF	+inner tone light				
28	HGS	21	A1250.53H	+Fin End 53H	\$ 39.00	\$ 10.65	\$ 223.65	72.700
			HF	+inner tone light				
			HF	+inner tone light				
29	HGS	3	A1250.67H	+Fin End 67H	\$ 40.00	\$ 10.92	\$ 32.76	72.700
			HF	+inner tone light				
			HF	+inner tone light				
30	HGS	1	A1260.39F	+Spacer Fabric 39H	\$ 138.00	\$ 37.67	\$ 37.67	72.700
			HF	+inner tone light				
			HF	+inner tone light				
			7M	+bailey-Pr Cat 1				
			01	+bailey belmont silver				
31	HGS	3	A1311.A	+Duplex Rcp,4-Circ A 6/Pkg	\$ 151.00	\$ 41.22	\$ 123.66	72.700
			HF	+inner tone light				
32	HGS	3	A1311.B	+Duplex Rcp,4-Circ B 6/Pkg	\$ 151.00	\$ 41.22	\$ 123.66	72.700
			HF	+inner tone light				
33	HGS	3	A1311.C	+Duplex Rcp,4-Circ C 6/Pkg	\$ 151.00	\$ 41.22	\$ 123.66	72.700
			HF	+inner tone light				
34	HGS	3	A1311.D	+Duplex Rcp,4-Circ D Dedicated 6/Pkg	\$ 151.00	\$ 41.22	\$ 123.66	72.700
			HF	+inner tone light				
35	HGS	9	A1322.06E	+Base Pwr Entry,Dir Con 4-Circ,6Fl L	\$ 120.00	\$ 32.76	\$ 294.84	72.700
36	HGS	1	A1355.30E	+Base Pwr Adapter,W/O Covers 4-Circ 30W	\$ 123.00	\$ 33.58	\$ 33.58	72.700
37	HGS	1	A1355.42E	+Base Pwr Adapter,W/O Covers 4-Circ 42W	\$ 123.00	\$ 33.58	\$ 33.58	72.700
38	HGS	9	A2310.2442L	+Work Surf,Sq-Edge Rect Lam 24D 42W	\$ 298.00	\$ 81.35	\$ 732.15	72.700
			8X	+kale				
			HF	+inner tone light				
39	HGS	2	A2310.2448L	+Work Surf,Sq-Edge Rect Lam 24D 48W	\$ 314.00	\$ 85.72	\$ 171.44	72.700
			8X	+kale				
			HF	+inner tone light				
				TAG: CUT FOR COLUMN				
40	HGS	2	A2310.2460L	+Work Surf,Sq-Edge Rect Lam 24D 60W	\$ 402.00	\$ 109.75	\$ 219.50	72.700
			8X	+kale				
			HF	+inner tone light				
41	HGS	9	A2310.2472L	+Work Surf,Sq-Edge Rect Lam 24D 72W	\$ 472.00	\$ 128.66	\$ 1,159.74	72.700
			8X	+kale				
			HF	+inner tone light				

LEE CO. HENDRY ST. 3RD FL: INTERNAL AUDIT
 F2984INTAUDITREV.SP4

Item	Cat	Qty	Part Number	Part Description	List \$	Sell \$	Ext Sell \$	Sell- %
42	HGS	2	A2310.3036L	+Work Surf,Sq-Edge Rect Lam 30D 36W	\$ 345.00	\$ 94.19	\$ 188.38	72.700
			8X	+kale				
			HF	+inner tone light				
43	HGS	1	A2310.3060L	+Work Surf,Sq-Edge Rect Lam 30D 60W	\$ 497.00	\$ 135.68	\$ 135.68	72.700
			8X	+kale				
			HF	+inner tone light				
44	HGS	11	A2310.3072L	+Work Surf,Sq-Edge Rect Lam 30D 72W	\$ 588.00	\$ 160.52	\$ 1,765.72	72.700
			8X	+kale				
			HF	+inner tone light				
45	HGS	1	A2352.3072L	+Penin,Sq-Edge Rect Lam 30D 72W	\$ 693.00	\$ 189.19	\$ 189.19	72.700
			8X	+kale				
			HF	+inner tone light				
46	HGS	2	A2380.24L	+Support Panel,Wk Surf,End Lam 24D	\$ 237.00	\$ 64.70	\$ 129.40	72.700
			HF	+inner tone light				
			HF	+inner tone light				
47	HGS	10	A2380.30L	+Support Panel,Wk Surf,End Lam 30D	\$ 268.00	\$ 73.16	\$ 731.60	72.700
			HF	+inner tone light				
			HF	+inner tone light				
48	HGS	1	A2381.29	+C-Leg	\$ 267.00	\$ 72.89	\$ 72.89	72.700
			HF	+inner tone light				
49	HGS	13	A3221.1324	+Shelf,B-Style 7-1/2H 13D 24W	\$ 97.00	\$ 26.48	\$ 344.24	72.700
			HF	+inner tone light				
50	HGS	4	A3221.1330	+Shelf,B-Style 7-1/2H 13D 30W	\$ 102.00	\$ 27.85	\$ 111.40	72.700
			HF	+inner tone light				
51	HGS	1	A3221.1336	+Shelf,B-Style 7-1/2H 13D 36W	\$ 109.00	\$ 29.76	\$ 29.76	72.700
			HF	+inner tone light				
52	HGS	10	A3221.1348	+Shelf,B-Style 7-1/2H 13D 48W	\$ 121.00	\$ 33.03	\$ 330.30	72.700
			HF	+inner tone light				
53	HGS	2	A3352.1324	+Flip Dr Unit,B-Style Fab,W/Lock 13D 24W 15-1/2H	\$ 387.00	\$ 105.65	\$ 211.30	72.700
			KD	+keyed differently				
			HF	+inner tone light				
			6B	+comet-Pr Cat 4				
			08	+Comet-Winter Solstice				
54	HGS	1	A3352.1330	+Flip Dr Unit,B-Style Fab,W/Lock 13D 30W 15-1/2H	\$ 406.00	\$ 110.84	\$ 110.84	72.700
			KD	+keyed differently				
			HF	+inner tone light				
			6B	+comet-Pr Cat 4				
			08	+Comet-Winter Solstice				
55	HGS	4	A3352.1336	+Flip Dr Unit,B-Style Fab,W/Lock 13D 36W 15-1/2H	\$ 434.00	\$ 118.48	\$ 473.92	72.700
			KD	+keyed differently				
			HF	+inner tone light				
			6B	+comet-Pr Cat 4				
			08	+Comet-Winter Solstice				
56	HGS	4	A3352.1342	+Flip Dr Unit,B-Style Fab,W/Lock 13D 42W 15-1/2H	\$ 463.00	\$ 126.40	\$ 505.60	72.700
			KD	+keyed differently				
			HF	+inner tone light				
			6B	+comet-Pr Cat 4				
			08	+Comet-Winter Solstice				
57	HGS	1	A3352.1348	+Flip Dr Unit,B-Style Fab,W/Lock 13D 48W 15-1/2H	\$ 486.00	\$ 132.68	\$ 132.68	72.700
			KD	+keyed differently				
			HF	+inner tone light				
			6B	+comet-Pr Cat 4				
			08	+Comet-Winter Solstice				
58	HGS	1	A3410.1224	+Tackboard,B-Style 12H 24W	\$ 149.00	\$ 40.68	\$ 40.68	72.700
			64	+flannel-Pr Cat 4				
			24	+flannel grape				
59	HGS	4	A3410.1236	+Tackboard,B-Style 12H 36W	\$ 158.00	\$ 43.13	\$ 172.52	72.700
			64	+flannel-Pr Cat 4				
			24	+flannel grape				
60	HGS	9	A3410.1248	+Tackboard,B-Style 12H 48W	\$ 174.00	\$ 47.50	\$ 427.50	72.700
			64	+flannel-Pr Cat 4				
			24	+flannel grape				

LEE CO. HENDRY ST. 3RD FL: INTERNAL AUDIT
 F2984INTAUDITREV.SP4

Item	Cat	Qty	Part Number	Part Description	List \$	Sell \$	Ext Sell \$	Sell. %
61	HGS	1	A3610.30	+Tool Bar,B-Style 4H 30W	\$ 64.00	\$ 17.47	\$ 17.47	72.700
			HF	+inner tone light				
62	HGS	1	A3610.36	+Tool Bar,B-Style 4H 36W	\$ 69.00	\$ 18.84	\$ 18.84	72.700
			HF	+inner tone light				
63	HAO	2	A3615.1624	+Tile,Rail Action Office® Series 2 24W	\$ 141.00	\$ 38.49	\$ 76.98	72.700
			HF	+inner tone light				
64	HAO	10	A3615.1636	+Tile,Rail Action Office® Series 2 36W	\$ 169.00	\$ 46.14	\$ 461.40	72.700
			HF	+inner tone light				
65	HST	15	AD10UB	+Side Chair,Stk,Aside,Uphol Outer Back	\$ 322.00	\$ 154.56	\$ 2,318.40	52.000
			MA	+metal arms				
			SG	+glide				
			MS	+metallic silver				
			32	+iota™-Pr Cat 3				
			12	+iota™ marsh ice				
66	HGS	3	AO210.34	+Wall Start 34H	\$ 33.00	\$ 9.01	\$ 27.03	72.700
			HF	+inner tone light				
67	HGS	3	AO210.62	+Wall Start 62H	\$ 35.00	\$ 9.56	\$ 28.68	72.700
			HF	+inner tone light				
68	HGS	3	AO213.60	+Wall Strip 60H	\$ 42.00	\$ 11.47	\$ 34.41	72.700
			HF	+inner tone light				
69	GU3	9	INSTALL	ATTACHMENT HARDWARE	\$ 29.16	\$ 7.96	\$ 71.64	72.700
70	HGS	14	AO215.34	+Draw Rod 34H	\$ 15.00	\$ 4.10	\$ 57.40	72.700
71	HGS	20	AO215.48	+Draw Rod 48H	\$ 16.00	\$ 4.37	\$ 87.40	72.700
72	HGS	15	AO215.62	+Draw Rod 62H	\$ 16.00	\$ 4.37	\$ 65.55	72.700
73	HGS	7	AO219.48	+Draw Rod,Chg-of-Ht 48H	\$ 16.00	\$ 4.37	\$ 30.59	72.700
74	HGS	7	AO251.	+Fin End,Chg-of-Ht,Panel/Panel	\$ 17.00	\$ 4.64	\$ 32.48	72.700
			HF	+inner tone light				
75	HGS	11	AO259.	+Fin End,Chg-Of-Ht,Panel/Conn	\$ 17.00	\$ 4.64	\$ 51.04	72.700
			HF	+inner tone light				
76	HGC	12	EE122AB	+Chair,Ergon 3 Pneu,Adj Arms,Knee Tilt,Sz B	\$ 1,048.00	\$ 338.82	\$ 4,065.84	67.670
			AJ	+adjustable				
			MT	+medium tone				
			BC	+2" hd dbl wl caster, carpet				
			U6	+nonupholstered				
			MT	+medium tone				
			32	+iota™-Pr Cat 3				
			12	+iota™ marsh ice				
77	HGC	1	EE122NB	+Chair,Ergon 3 Pneu,No Arms,Knee Tilt,Sz B	\$ 853.00	\$ 275.77	\$ 275.77	67.670
			AJ	+adjustable				
			MT	+medium tone				
			BC	+2" hd dbl wl caster, carpet				
			U6	+nonupholstered				
			32	+iota™-Pr Cat 3				
			12	+iota™ marsh ice				
78	HGS	1	ET102L	+Table,Rnd Univ Base Vinyl Edge/Lam Top 28.5H	\$ 480.00	\$ 131.04	\$ 131.04	72.700
			8X	+kale				
			HF	+inner tone light				
			HF	+inner tone light				
			HF	+inner tone light				
79	MER	1	F16-1518-BBF	+Freestanding Ped Std Pull 15W 18D 26-1/4H (BBF)	\$ 589.00	\$ 226.06	\$ 226.06	61.620
			TS	+Textured Steel				
			HF	+inner tone Light non-metallic				
			T2	+Square Metal Top 1-1/4				
			KA	+Keyed Alike				
			B2	+Base 1-1/2				
			CB	+Counterweight(recommended)				
			C	+Std. Compressor				

LEE CO. HENDRY ST. 3RD FL: INTERNAL AUDIT
 F2984INTAUDITREV.SP4

Item	Cat	Qty	Part Number	Part Description	List \$	Sell \$	Ext Sell \$	Sell- %
80	MER	1	F16-1518-FF	+Freestanding Ped Std Pull 15W 18D 26-1/4H (FF)	\$ 567.00	\$ 217.61	\$ 217.61	61.620
			TS	+Textured Steel				
			HF	+inner tone Light non-metallic				
			T2	+Square Metal Top 1-1/4				
			KA	+Keyed Alike				
			B2	+Base 1-1/2				
			CB	+Counterweight(recommended)				
			C	+Std. Compressor				
81	HGS	12	G5010.	+Drw.Pencil 21W 16D	\$ 42.00	\$ 11.47	\$ 137.64	72.700
			HF	+inner tone light				
82	HGS	11	G5120.19	+Ped,B-Frt Stationary 6,6,12 27H 20D 15W	\$ 670.00	\$ 182.91	\$ 2,012.01	72.700
			HF	+inner tone light				
			KD	+keyed differently				
83	HGS	11	G5130.19	+Ped,B-Frt Stationary 12,12 27H 20D 15W	\$ 645.00	\$ 176.09	\$ 1,936.99	72.700
			HF	+inner tone light				
			KD	+keyed differently				
84	HGS	5	G6120.24MEN	+Task Light,E.E. Electronic Ballast/No Dimmer 24W	\$ 200.00	\$ 54.60	\$ 273.00	72.700
			HF	+inner tone light				
85	HGS	5	G6120.30MEN	+Task Light,E.E. Electronic Ballast/No Dimmer 30W	\$ 218.00	\$ 59.51	\$ 297.55	72.700
			HF	+inner tone light				
86	HGS	5	G6120.36MEN	+Task Light,E.E. Electronic Ballast/No Dimmer 36W	\$ 224.00	\$ 61.15	\$ 305.75	72.700
			HF	+inner tone light				
87	HGS	4	G6120.42MEN	+Task Light,E.E. Electronic Ballast/No Dimmer 42W	\$ 234.00	\$ 63.88	\$ 255.52	72.700
			HF	+inner tone light				
88	HGS	1	G6120.48MEN	+Task Light,E.E. Electronic Ballast/No Dimmer 48W	\$ 239.00	\$ 65.25	\$ 65.25	72.700
			HF	+inner tone light				
89	HGS	1	G7000.29	+Tool Rail,Wk Surf Att,29W	\$ 250.00	\$ 68.25	\$ 68.25	72.700
			HF	+inner tone light				
90	HGS	24	G7110.10	+Paper Tray 10W	\$ 32.00	\$ 8.74	\$ 209.76	72.700
			HF	+inner tone light				
91	HGS	12	G7130.	+Diag Tray	\$ 51.00	\$ 13.92	\$ 167.04	72.700
			HF	+inner tone light				
92	HGS	12	G7310.15	+Mini-Shelf 15W	\$ 46.00	\$ 12.56	\$ 150.72	72.700
			HF	+inner tone light				
93	HGS	1	G7715.04K	+Keybd Tray,Fully Adj,Std-Length Arm,Knob Adj	\$ 356.00	\$ 97.19	\$ 97.19	72.700
			HF	+inner tone light				
94	HGS	1	G7742.	+Mouse Tray,Wk Surf Att,Adj/Storable	\$ 206.00	\$ 56.24	\$ 56.24	72.700
95	HGC	4	WC410P	+Chair,Caper® Multipurpose Stacking,Molded Seat,Fixed Arms	\$ 255.00	\$ 100.44	\$ 401.76	60.610
			MS	+metallic silver				
			EM	+evergreen				
			Y6	+nylon glide with molded insert, carpet or hard floors				
			SY	+silver grey				
96	HPS	1	PA2LE.BM22N	+Crm,Ext,30x48x72x24,Lam Top/Vin Ed,L Rec Leg/R Rec Leg,Nonpwr	\$ 1,480.00	\$ 657.71	\$ 657.71	55.560
			1209	+platinum				
			8X	+kale				
			SG	+slate grey				
			-	+specification complete				
97	HPS	1	PB1LE.DE24N	+Rec,24x48,Lam Top/Vin Ed,L Rec Leg/R Full End,Nonpwr	\$ 825.00	\$ 366.63	\$ 366.63	55.560
			1209	+platinum				
			8X	+kale				
			SG	+slate grey				
			-	+specification complete				
98	HPS	1	PC2LE.GD42N	+Ellip Pen,72x30,Lam Top/Vin Ed,L Full End/R Rec Leg,Nonpwr	\$ 1,620.00	\$ 719.93	\$ 719.93	55.560
			1209	+platinum				
			8X	+kale				
			SG	+slate grey				
			MP	+24" modesty panel				
			-	+specification complete				
99	HPS	1	PH200.1848S	+Screen,Stack,Straight End,18Hx48W	\$ 275.00	\$ 122.21	\$ 122.21	55.560
			64	+flannel-Pr Cat 4				
			24	+flannel grape				
			64	+flannel-Pr Cat 4				
			24	+flannel grape				

LEE CO. HENDRY ST. 3RD FL: INTERNAL AUDIT
 F2984INTAUDITREV.SP4

Item	Cat	Qty	Part Number	Part Description	List \$	Sell \$	Ext Sell \$	Sell- %
100	HPS	1	PH200.1872R	+Screen,Stack,Bev L End for R Side of Corner,18Hx72W	\$ 325.00	\$ 144.43	\$ 144.43	55.560
			64	+flannel-Pr Cat 4				
			24	+flannel grape				
			64	+flannel-Pr Cat 4				
			24	+flannel grape				
101	HPS	1	PJ100.48B	+Flipper Door Unit,Std Lift/Close,Fabric Front,48W	\$ 705.00	\$ 313.30	\$ 313.30	55.560
			1209	+platinum				
			6B	+comet-Pr Cat 4				
			08	+comet winter solstice				
			KA	+keyed alike				
			-	+specification complete				
102	HPS	1	PJ110.71B	+Flipper Door Unit,Cnr,Std Lift/Close,Fabric Front,71W	\$ 935.00	\$ 415.51	\$ 415.51	55.560
			1209	+platinum				
			6B	+comet-Pr Cat 4				
			08	+comet winter solstice				
			KA	+keyed alike				
			-	+specification complete				
103	HPS	1	PM120.42MEN	+Task Light,Energy Eff,Local/ Can,Elec Blst,No Dim	\$ 220.00	\$ 97.77	\$ 97.77	55.560
104	HPS	1	PM120.60MEN	+Task Light,Energy Eff,Local/ Can,Elec Blst,No Dim	\$ 245.00	\$ 108.88	\$ 108.88	55.560
105	NT1	1	OP-S2120	OCCASIONAL TABLE HPL - CUBE	\$ 385.00	\$ 152.46	\$ 152.46	60.400
			440	CLOUD				
106	GU1	32	SUBC-INSTALLATION	TO RECEIVE, DELIVER AND INSTALL SEATING PER STATE OF FLORIDA CONTRACT GUIDELINES	\$ 10.01	\$ 10.00	\$ 320.00	0.100
107	GU1	1	SUBC-INSTALLATION	TO RECEIVE, DELIVER AND INSTALL PRODUCT	\$ 8,650.01	\$ 8,650.00	\$ 8,650.00	0.000
108	651	48	DESIGN	DESIGN SERVICES SPEC ENTERED 2/14/03 REVISED 5/7/03	\$ 55.01	\$ 55.00	\$ 2,640.00	0.018
				Grand Total			\$ 61,901.22	65.871

LEE CO. HENDRY ST. 3RD FL: PURCHASING
F2136.SP4

Item	Cat	Qty	Part Number	Part Description	List \$	Sell \$	Ext Sell \$	Sell- %
1	MER	1	26-3620-2N	+File,FS Lat Std Pull,2 Dwr TS HF T2 KD B2 CB 9R +textured steel +inner tone light +1 1/4"-high painted metal top with squared edge +keyed differently, black +1 1/2"-high base +counterweight (recommended) +side-to-side filing rail	\$ 755.00	\$ 282.14	\$ 282.14	62.630
2	MER	14	26-3620-3N	+File,FS Lat Std Pull,3 Dwr TS HF T2 KD B2 CB 9R +textured steel +inner tone light +1 1/4"-high painted metal top with squared edge +keyed differently, black +1 1/2"-high base +counterweight (recommended) +side-to-side filing rail	\$ 1,006.00	\$ 375.94	\$ 5,263.16	62.630
3	MER	5	26-3620-5D	+File,FS Lat Std Pull,1 FD/4 Dwr TS HF T2 KD B2 CB 9R +textured steel +inner tone light +1 1/4"-high painted metal top with squared edge +keyed differently, black +1 1/2"-high base +counterweight (recommended) +side-to-side filing rail	\$ 1,540.00	\$ 575.50	\$ 2,877.50	62.630
4	MER	12	26-4220-5D	+File,FS Lat Std Pull,1 FD/4 Dwr TS HF T2 KD B2 CB 9R +textured steel +inner tone light +1 1/4"-high painted metal top with squared edge +keyed differently, black +1 1/2"-high base +counterweight (recommended) +side-to-side filing rail	\$ 1,722.00	\$ 643.51	\$ 7,722.12	62.630
5	MER	2	46-3020-38	+Storage Case Std Pull 30W 20D 38H TS HF NS2 KD T2 Y B2 +Textured Steel +inner tone Light non-metallic +Two Shelves +Black - Keyed Differently +Square Edge Metal Top 1-1/4 +With Doors +1-1/2in Base	\$ 557.00	\$ 208.15	\$ 416.30	62.630
6	MER	2	46-3620-38	+Storage Case Std Pull 36W 20D 38H TS HF NS2 KD T2 Y B2 +Textured Steel +inner tone Light non-metallic +Two Shelves +Black - Keyed Differently +Square Edge Metal Top 1-1/4 +With Doors +1-1/2in Base	\$ 631.00	\$ 235.80	\$ 471.60	62.630
7	MER	2	46-3620-69	+Storage Case Std Pull 36W 20D 68-3/8H TS HF NS4 KD T2 Y B2 +Textured Steel +inner tone Light non-metallic +Four Shelves +Black - Keyed Differently +Square Edge Metal Top 1-1/4 +With Doors +1-1/2in Base	\$ 916.00	\$ 342.31	\$ 684.62	62.630
8	HGS	7	A1120.3924G	+Panel,Fabric 4-Circ W/Com Pt Lc 39H 24W HF HF 7M 01 7M 01 +inner tone light +inner tone light +bailey-Pr Cat 1 +bailey belmont silver +bailey-Pr Cat 1 +bailey belmont silver	\$ 432.00	\$ 117.94	\$ 825.58	72.700

LEE CO. HENDRY ST. 3RD FL: PURCHASING
F2136.SP4

Item	Cat	Qty	Part Number	Part Description	List \$	Sell \$	Ext Sell \$	Sell-%
9	HGS	6	A1120.3930G	+Panel,Fabric 4-Circ W/Com Pt Lc 39H 30W +inner tone light +inner tone light +bailey-Pr Cat 1 +bailey belmont silver +bailey-Pr Cat 1 +bailey belmont silver	\$ 461.00	\$ 125.85	\$ 755.10	72.700
10	HGS	1	A1120.3936G	+Panel,Fabric 4-Circ W/Com Pt Lc 39H 36W +inner tone light +inner tone light +bailey-Pr Cat 1 +bailey belmont silver +bailey-Pr Cat 1 +bailey belmont silver	\$ 504.00	\$ 137.59	\$ 137.59	72.700
11	HGS	1	A1120.3942G	+Panel,Fabric 4-Circ W/Com Pt Lc 39H 42W +inner tone light +inner tone light +bailey-Pr Cat 1 +bailey belmont silver +bailey-Pr Cat 1 +bailey belmont silver	\$ 525.00	\$ 143.33	\$ 143.33	72.700
12	HGS	7	A1120.3948G	+Panel,Fabric 4-Circ W/Com Pt Lc 39H 48W +inner tone light +inner tone light +bailey-Pr Cat 1 +bailey belmont silver +bailey-Pr Cat 1 +bailey belmont silver	\$ 545.00	\$ 148.79	\$ 1,041.53	72.700
13	HGS	12	A1120.6724G	+Panel,Fabric 4-Circ W/Com Pt Lc 67H 24W +inner tone light +inner tone light +bailey-Pr Cat 1 +bailey belmont silver +bailey-Pr Cat 1 +bailey belmont silver	\$ 511.00	\$ 139.50	\$ 1,674.00	72.700
14	HGS	2	A1120.6730J	+Panel,Fabric Npwr W/Rcp Com Pt Lc 67H 30W +inner tone light +inner tone light +bailey-Pr Cat 1 +bailey belmont silver +bailey-Pr Cat 1 +bailey belmont silver	\$ 435.00	\$ 118.76	\$ 237.52	72.700
15	HGS	8	A1120.6730G	+Panel,Fabric 4-Circ W/Com Pt Lc 67H 30W +inner tone light +inner tone light +bailey-Pr Cat 1 +bailey belmont silver +bailey-Pr Cat 1 +bailey belmont silver	\$ 558.00	\$ 152.33	\$ 1,218.64	72.700
16	HGS	3	A1120.6736G	+Panel,Fabric 4-Circ W/Com Pt Lc 67H 36W +inner tone light +inner tone light +bailey-Pr Cat 1 +bailey belmont silver +bailey-Pr Cat 1 +bailey belmont silver	\$ 626.00	\$ 170.90	\$ 512.70	72.700
17	HGS	5	A1120.6748G	+Panel,Fabric 4-Circ W/Com Pt Lc 67H 48W +inner tone light +inner tone light +bailey-Pr Cat 1 +bailey belmont silver +bailey-Pr Cat 1 +bailey belmont silver	\$ 694.00	\$ 189.46	\$ 947.30	72.700

LEE CO. HENDRY ST. 3RD FL: PURCHASING
F2136.SP4

Item	Cat	Qty	Part Number	Part Description	List \$	Sell \$	Ext Sell \$	Sell- %
18	HGS	5	A1120.8524G	+Panel,Fabric 4-Circ W/Com Pt Lc 85H 24W	\$ 581.00	\$ 158.61	\$ 793.05	72.700
			HF	+inner tone light				
			HF	+inner tone light				
			7M	+bailey-Pr Cat 1				
			01	+bailey belmont silver				
			7M	+bailey-Pr Cat 1				
			01	+bailey belmont silver				
19	HGS	3	A1120.8530G	+Panel,Fabric 4-Circ W/Com Pt Lc 85H 30W	\$ 631.00	\$ 172.26	\$ 516.78	72.700
			HF	+inner tone light				
			HF	+inner tone light				
			7M	+bailey-Pr Cat 1				
			01	+bailey belmont silver				
			7M	+bailey-Pr Cat 1				
			01	+bailey belmont silver				
20	HGS	5	A1120.8536J	+Panel,Fabric Npwr W/Rcp Com Pt Lc 85H 36W	\$ 587.00	\$ 160.25	\$ 801.25	72.700
			HF	+inner tone light				
			HF	+inner tone light				
			7M	+bailey-Pr Cat 1				
			01	+bailey belmont silver				
			7M	+bailey-Pr Cat 1				
			01	+bailey belmont silver				
21	HGS	6	A1120.8548G	+Panel,Fabric 4-Circ W/Com Pt Lc 85H 48W	\$ 786.00	\$ 214.58	\$ 1,287.48	72.700
			HF	+inner tone light				
			HF	+inner tone light				
			7M	+bailey-Pr Cat 1				
			01	+bailey belmont silver				
			7M	+bailey-Pr Cat 1				
			01	+bailey belmont silver				
22	HAO	4	A1165.6724J	+Panel,Partial-Glazed No Pwr W/Rcp & Com Pt Lc 67H 24W	\$ 1,079.00	\$ 294.57	\$ 1,178.28	72.700
			TR	+clear				
			HF	+inner tone light				
			HF	+inner tone light				
			7M	+bailey-Pr Cat 1				
			01	+bailey belmont silver				
			7M	+bailey-Pr Cat 1				
			01	+bailey belmont silver				
23	HAO	12	A1165.6730J	+Panel,Partial-Glazed No Pwr W/Rcp & Com Pt Lc 67H 30W	\$ 1,109.00	\$ 302.76	\$ 3,633.12	72.700
			TR	+clear				
			HF	+inner tone light				
			HF	+inner tone light				
			7M	+bailey-Pr Cat 1				
			01	+bailey belmont silver				
			7M	+bailey-Pr Cat 1				
			01	+bailey belmont silver				
24	HAO	6	A1165.6736J	+Panel,Partial-Glazed No Pwr W/Rcp & Com Pt Lc 67H 36W	\$ 1,139.00	\$ 310.95	\$ 1,865.70	72.700
			TR	+clear				
			HF	+inner tone light				
			HF	+inner tone light				
			7M	+bailey-Pr Cat 1				
			01	+bailey belmont silver				
			7M	+bailey-Pr Cat 1				
			01	+bailey belmont silver				
25	HAO	10	A1165.6748J	+Panel,Partial-Glazed No Pwr W/Rcp & Com Pt Lc 67H 48W	\$ 1,217.00	\$ 332.24	\$ 3,322.40	72.700
			TR	+clear				
			HF	+inner tone light				
			HF	+inner tone light				
			7M	+bailey-Pr Cat 1				
			01	+bailey belmont silver				
			7M	+bailey-Pr Cat 1				
			01	+bailey belmont silver				
26	HAO	1	A1165.8530C	+Panel,Partial-Glazed Npwr W/Rcp Lc 85H 30W	\$ 1,187.00	\$ 324.05	\$ 324.05	72.700
			TR	+clear				
			HF	+inner tone light				
			HF	+inner tone light				
			7M	+bailey-Pr Cat 1				
			01	+bailey belmont silver				
			7M	+bailey-Pr Cat 1				
			01	+bailey belmont silver				

LEE CO. HENDRY ST. 3RD FL: PURCHASING
F2136.SP4

Item	Cat	Qty	Part Number	Part Description	List \$	Sell \$	Ext Sell \$	Sell-%
27	HAO	16	A1165.8536J	+Panel,Partial-Glazed No Pwr W/Rcp & Com Pt Lc 85H 36W +clear +inner tone light +inner tone light +bailey-Pr Cat 1 +bailey belmont silver +bailey-Pr Cat 1 +bailey belmont silver	\$ 1,229.00	\$ 335.52	\$ 5,368.32	72.700
			TR					
			HF					
			HF					
			7M					
			01					
			7M					
			01					
28	HGS	1	A1220.39H	+Conn,2-Way 90 Deg Hard 39H +inner tone light +inner tone light	\$ 84.00	\$ 22.93	\$ 22.93	72.700
			HF					
			HF					
29	HGS	4	A1220.67H	+Conn,2-Way 90 Deg Hard 67H +inner tone light +inner tone light	\$ 107.00	\$ 29.21	\$ 116.84	72.700
			HF					
			HF					
30	HGS	6	A1220.85H	+Conn,2-Way 90 Deg Hard 85H +inner tone light +inner tone light	\$ 121.00	\$ 33.03	\$ 198.18	72.700
			HF					
			HF					
31	HGS	8	A1230.67H	+Conn,3-Way 90 Deg Hard 67H +inner tone light +inner tone light	\$ 191.00	\$ 52.14	\$ 417.12	72.700
			HF					
			HF					
32	HGS	6	A1230.85H	+Conn,3-Way 90 Deg Hard 85H +inner tone light +inner tone light	\$ 217.00	\$ 59.24	\$ 355.44	72.700
			HF					
			HF					
33	HGS	3	A1240.67H	+Conn,4-Way 90 Deg 67H +inner tone light	\$ 247.00	\$ 67.43	\$ 202.29	72.700
			HF					
34	HGS	7	A1250.39H	+Fin End 39H +inner tone light +inner tone light	\$ 35.00	\$ 9.56	\$ 66.92	72.700
			HF					
			HF					
35	HGS	1	A1250.39T	+Fin End,W/Trans Surf End Support 39H +inner tone light +inner tone light	\$ 55.00	\$ 15.02	\$ 15.02	72.700
			HF					
			HF					
36	HGS	16	A1250.67H	+Fin End 67H +inner tone light +inner tone light	\$ 40.00	\$ 10.92	\$ 174.72	72.700
			HF					
			HF					
37	HGS	10	A1250.85H	+Fin End 85H +inner tone light +inner tone light	\$ 44.00	\$ 12.01	\$ 120.10	72.700
			HF					
			HF					
38	HGS	8	A1322.06E	+Base Pwr Entry,Dir Con 4-Circ,6FI L	\$ 120.00	\$ 32.76	\$ 262.08	72.700
39	HGS	2	A1355.30E	+Base Pwr Adapter,W/O Covers 4-Circ 30W	\$ 123.00	\$ 33.58	\$ 67.16	72.700
40	HGS	10	A1355.48E	+Base Pwr Adapter,W/O Covers 4-Circ 48W	\$ 123.00	\$ 33.58	\$ 335.80	72.700
41	HGS	1	A2310.2424L	+Work Surf,Sq-Edge Rect Lam 24D 24W +kale +inner tone light	\$ 219.00	\$ 59.79	\$ 59.79	72.700
			8X					
			HF					
42	HGS	1	A2310.2430L	+Work Surf,Sq-Edge Rect Lam 24D 30W +kale +inner tone light	\$ 243.00	\$ 66.34	\$ 66.34	72.700
			8X					
			HF					
43	HGS	1	A2310.2436L	+Work Surf,Sq-Edge Rect Lam 24D 36W +kale +inner tone light	\$ 279.00	\$ 76.17	\$ 76.17	72.700
			8X					
			HF					
44	HGS	13	A2310.2448L	+Work Surf,Sq-Edge Rect Lam 24D 48W +kale +inner tone light	\$ 314.00	\$ 85.72	\$ 1,114.36	72.700
			8X					
			HF					
45	HGS	6	A2310.2472L	+Work Surf,Sq-Edge Rect Lam 24D 72W +kale +inner tone light	\$ 472.00	\$ 128.86	\$ 773.16	72.700
			8X					
			HF					
46	HGS	2	A2310.3036L	+Work Surf,Sq-Edge Rect Lam 30D 36W +kale +inner tone light	\$ 345.00	\$ 94.19	\$ 188.38	72.700
			8X					
			HF					

LEE CO. HENDRY ST. 3RD FL: PURCHASING
F2136.SP4

Item	Cat	Qty	Part Number	Part Description	List \$	Sell \$	Ext Sell \$	Sell- %
47	HGS	16	A2310.3072L	+Work Surf,Sq-Edge Rect Lam 30D 72W +kale +inner tone light	\$ 588.00	\$ 160.52	\$ 2,568.32	72.700
48	HGS	1	A2310.3078L	+Work Surf,Sq-Edge Rect Lam 30D 78W +kale +inner tone light	\$ 629.00	\$ 171.72	\$ 171.72	72.700
49	HGS	1	A2310.3084L	+Work Surf,Sq-Edge Rect Lam 30D 84W +kale +inner tone light	\$ 661.00	\$ 180.45	\$ 180.45	72.700
50	HGS	1	A2332.2448L	+Work Surf,Sq-Edge Cor Lam 24D 48W +kale +inner tone light	\$ 513.00	\$ 140.05	\$ 140.05	72.700
51	HAO	7	A2380.24L	+Support Panel,Wk Surf,End Lam 24D +inner tone light	\$ 237.00	\$ 64.70	\$ 452.90	72.700
52	HAO	14	A2380.30L	+Support Panel,Wk Surf,End Lam 30D +inner tone light	\$ 268.00	\$ 73.16	\$ 1,024.24	72.700
53	HAO	19	A2391.L	+Corner Wedge 16W +kale	\$ 88.00	\$ 24.02	\$ 456.38	72.700
54	HAO	1	A2830.1442L	+Trans Surf,Sq-Edge Rect Lam Top 42W +kale	\$ 152.00	\$ 41.50	\$ 41.50	72.700
55	HC2	1	Z29LA	@Vary Easy AO2 Sq-Edge Vinyl Corner Trans Top,Lam Top @30 LH, 30 RH @Kale Skipped Option	\$ 302.00	\$ 82.45	\$ 82.45	72.700
56	HAO	9	A3221.1324	+Shelf,B-Style 7-1/2H 13D 24W +inner tone light	\$ 97.00	\$ 26.48	\$ 238.32	72.700
57	HAO	8	A3221.1330	+Shelf,B-Style 7-1/2H 13D 30W +inner tone light	\$ 102.00	\$ 27.85	\$ 222.80	72.700
58	HAO	2	A3221.1336	+Shelf,B-Style 7-1/2H 13D 36W +inner tone light	\$ 109.00	\$ 29.76	\$ 59.52	72.700
59	HAO	7	A3221.1348	+Shelf,B-Style 7-1/2H 13D 48W +inner tone light	\$ 121.00	\$ 33.03	\$ 231.21	72.700
60	HAO	8	A3352.1324	+Flip Dr Unit,B-Style Fab,W/Lock 13D 24W 15-1/2H +keyed differently +inner tone light +comet-Pr Cat 4 +comet winter solstice	\$ 387.00	\$ 105.65	\$ 845.20	72.700
61	HAO	8	A3352.1330	+Flip Dr Unit,B-Style Fab,W/Lock 13D 30W 15-1/2H +keyed differently +inner tone light +comet-Pr Cat 4 +comet winter solstice	\$ 406.00	\$ 110.84	\$ 886.72	72.700
62	HAO	6	A3352.1336	+Flip Dr Unit,B-Style Fab,W/Lock 13D 36W 15-1/2H +keyed differently +inner tone light +comet-Pr Cat 4 +comet winter solstice	\$ 434.00	\$ 118.48	\$ 710.88	72.700
63	HAO	2	A3352.1342	+Flip Dr Unit,B-Style Fab,W/Lock 13D 42W 15-1/2H +keyed differently +inner tone light +comet-Pr Cat 4 +comet winter solstice	\$ 463.00	\$ 126.40	\$ 252.80	72.700
64	HAO	14	A3352.1348	+Flip Dr Unit,B-Style Fab,W/Lock 13D 48W 15-1/2H +keyed differently +inner tone light +comet-Pr Cat 4 +comet winter solstice	\$ 486.00	\$ 132.68	\$ 1,857.52	72.700

LEE CO. HENDRY ST. 3RD FL: PURCHASING
F2136.SP4

Item	Cat	Qty	Part Number	Part Description	List \$	Sell \$	Ext Sell \$	Sell- %
65	HAO	14	A3410.1248	+Tackboard,B-Style 12H 48W	\$ 174.00	\$ 47.50	\$ 665.00	72.700
			64	+flannel-Pr Cat 4				
			24	+flannel grape				
66	HAO	5	A3615.1624	+Tile,Rail Action Office® Series 2 24W	\$ 141.00	\$ 38.49	\$ 192.45	72.700
			HF	+inner tone light				
67	HAO	6	A3615.1630	+Tile,Rail Action Office® Series 2 30W	\$ 156.00	\$ 42.59	\$ 255.54	72.700
			HF	+inner tone light				
68	HAO	2	A3615.1636	+Tile,Rail Action Office® Series 2 36W	\$ 169.00	\$ 46.14	\$ 92.28	72.700
			HF	+inner tone light				
69	HAO	1	A3615.1642	+Tile,Rail Action Office® Series 2 42W	\$ 184.00	\$ 50.23	\$ 50.23	72.700
			HF	+inner tone light				
70	HAO	12	A3615.1648	+Tile,Rail Action Office® Series 2 48W	\$ 198.00	\$ 54.05	\$ 648.60	72.700
			HF	+inner tone light				
71	HST	11	AD10UB	+Side Chair,Stk,Aside,Uphol Outer Back	\$ 322.00	\$ 154.56	\$ 1,700.16	52.000
			MA	+metal arms				
			SG	+glide				
			MS	+metallic silver				
			32	+iota™-Pr Cat 3				
			12	+iota™ marsh ice				
72	HGC	4	AE121AWB	+Chair,Aeron Wk,Two-Stage Pneu.,Std. Tilt,Adj Arms	\$ 1,075.00	\$ 434.30	\$ 1,737.20	59.600
			AJ	+adjustable lumbar support				
			G1	+graphite				
			BB	+2 1/2" hard caster, black yoke, carpet				
			BK	+black				
			3D	+pellicle® classic-Pr Cat 1				
				Skipped Option				
73	HGC	3	AE121AWC	+Chair,Aeron Wk,Two-Stage Pneu.,Std. Tilt,Adj Arms	\$ 1,075.00	\$ 434.30	\$ 1,302.90	59.600
			AJ	+adjustable lumbar support				
			G1	+graphite				
			BB	+2 1/2" hard caster, black yoke, carpet				
			BK	+black				
			3D	+pellicle® classic-Pr Cat 1				
				Skipped Option				
74	HGS	5	AO213.84	+Wall Strip 84H	\$ 49.00	\$ 13.38	\$ 66.90	72.700
			HF	+inner tone light				
75	GU1	5	SUBC-INSTALLATION	WALL STRIP ATTACHMENT HARDWARE	\$ 29.16	\$ 7.96	\$ 39.80	72.700
76	HGS	13	AO215.34	+Draw Rod 34H	\$ 15.00	\$ 4.10	\$ 53.30	72.700
77	HGS	32	AO215.62	+Draw Rod 62H	\$ 16.00	\$ 4.37	\$ 139.84	72.700
78	HGS	19	AO215.80	+Draw Rod 80H	\$ 17.00	\$ 4.64	\$ 88.16	72.700
79	HGS	8	AO259.	+Fin End,Chg-Of-Ht,Panel/Conn	\$ 17.00	\$ 4.64	\$ 37.12	72.700
			HF	+inner tone light				
80	HGS	1	AO460.	+Trans Surf Support,Center	\$ 28.00	\$ 7.64	\$ 7.64	72.700
			HF	+inner tone light				
81	HGS	2	AO463.	+Trans Surf Support,Mid-End	\$ 27.00	\$ 7.37	\$ 14.74	72.700
			HF	+inner tone light				
82	HGC	4	EE122AB	+Chair,Ergon 3 Pneu,Adj Arms,Knee Tilt,Sz B	\$ 1,048.00	\$ 338.82	\$ 1,355.28	67.670
			AJ	+adjustable				
			MT	+medium tone				
			BC	+2" hd dbl wl caster, carpet				
			U6	+nonupholstered				
			MT	+medium tone				
			32	+iota™-Pr Cat 3				
			12	+iota™ marsh ice				

LEE CO. HENDRY ST. 3RD FL: PURCHASING
F2136.SP4

Item	Cat	Qty	Part Number	Part Description	List \$	Sell \$	Ext Sell \$	Sell- %
83	HGC	1	EE122AC	+Chair,Ergon 3 Pneu,Adj Arms,Knee Tilt,Sz C	\$ 1,048.00	\$ 338.82	\$ 338.82	67.670
			AJ	+adjustable				
			MT	+medium tone				
			BC	+2" hd dbl wl caster, carpet				
			U6	+nonupholstered				
			MT	+medium tone				
			32	+iota™-Pr Cat 3				
			12	+iota™ marsh ice				
84	HGS	14	G5010.	+Drw,Pencil 21W 16D	\$ 42.00	\$ 11.47	\$ 160.58	72.700
			HF	+inner tone light				
85	HGS	14	G5120.19	+Ped,B-Frt Stationary 6,6,12 27H 20D 15W	\$ 670.00	\$ 182.91	\$ 2,560.74	72.700
			HF	+inner tone light				
			KD	+keyed differently				
86	HGS	13	G5130.19	+Ped,B-Frt Stationary 12,12 27H 20D 15W	\$ 645.00	\$ 176.09	\$ 2,289.17	72.700
			HF	+inner tone light				
			KD	+keyed differently				
87	HGS	10	G6120.24MEN	+Task Light,E.E. Electronic Ballast/No Dimmer 24W	\$ 200.00	\$ 54.60	\$ 546.00	72.700
			HF	+inner tone light				
88	HGS	14	G6120.30MEN	+Task Light,E.E. Electronic Ballast/No Dimmer 30W	\$ 218.00	\$ 59.51	\$ 833.14	72.700
			HF	+inner tone light				
89	HGS	2	G6120.36MEN	+Task Light,E.E. Electronic Ballast/No Dimmer 36W	\$ 224.00	\$ 61.15	\$ 122.30	72.700
			HF	+inner tone light				
90	HGS	1	G6120.42MEN	+Task Light,E.E. Electronic Ballast/No Dimmer 42W	\$ 234.00	\$ 63.88	\$ 63.88	72.700
			HF	+inner tone light				
91	HGS	15	G6120.48MEN	+Task Light,E.E. Electronic Ballast/No Dimmer 48W	\$ 239.00	\$ 65.25	\$ 978.75	72.700
			HF	+inner tone light				
92	HGS	30	G7110.10	+Paper Tray 10W	\$ 32.00	\$ 8.74	\$ 262.20	72.700
			HF	+inner tone light				
93	HGS	15	G7130.	+Diag Tray	\$ 51.00	\$ 13.92	\$ 208.80	72.700
			HF	+inner tone light				
94	HGS	15	G7310.15	+Mini-Shelf 15W	\$ 46.00	\$ 12.56	\$ 188.40	72.700
			HF	+inner tone light				
95	HGS	13	G7715.04K	+Keybd Tray,Fully Adj,Std-Length Arm,Knob Adj	\$ 356.00	\$ 97.19	\$ 1,263.47	72.700
			HF	+inner tone light				
96	HGS	1	G7715.08K	+Keybd Tray,Fully Adj,Knob Adj 21In Trk	\$ 382.00	\$ 104.29	\$ 104.29	72.700
			HF	+inner tone light				
97	HGS	14	G7742.	+Mouse Tray,Wk Surf Att,Adj/Storable	\$ 206.00	\$ 56.24	\$ 787.36	72.700
			HF	+inner tone light				
98	HGN	6	NPA10.3072L	@Shell,Sq-Edge,Lam,30D 72W	\$ 1,317.00	\$ 359.54	\$ 2,157.24	72.700
			HF	@inner tone light				
99	HST	5	WC410P	+Chair,Caper® Multipurpose Stacking,Molded Seat,Fixed Arms	\$ 255.00	\$ 100.44	\$ 502.20	60.610
			MS	+metallic silver				
			EM	+evergreen				
			Y6	+nylon glide with molded insert, carpet or hard floors				
			SY	+silver grey				
100	HGN	1	ET123L	+Table,Rnd Seg Base Vin Edge/Lam Top 28.5H	\$ 845.00	\$ 230.69	\$ 230.69	72.700
			HF	48Dia				
			HF	+inner tone light				
			HF	Skipped Option				
101	NT1	1	31-3672RHA	RIGHT PEDESTAL DESK ARC TOP FULL PED HPL	\$ 2,114.00	\$ 837.14	\$ 837.14	60.400
			MC	AMBER				
102	NT1	1	2421CDF	WOOD CENTER DRAWER	\$ 158.00	\$ 62.57	\$ 62.57	60.400
			MC	AMBER				
103	NT1	1	31-2448UP	BRIDGE HPL TOP 24 X 48	\$ 317.00	\$ 125.53	\$ 125.53	60.400
			MC	AMBER				
104	NT1	1	31-2172LP2	SINGLE PEDESTAL CREDENZA LEFT HPL TOP	\$ 1,380.00	\$ 546.48	\$ 546.48	60.400
			MC	W/LATERAL FILE				
			MC	AMBER				

LEE CO. HENDRY ST. 3RD FL: PURCHASING
F2136.SP4

Item	Cat	Qty	Part Number	Part Description	List \$	Sell \$	Ext Sell \$	Sell. %
105	NT1	1	31-1572OSC MC	HIGHBACK ORGANIZER 15X72 AMBER	\$ 1,398.00	\$ 553.61	\$ 553.61	60.400
106	NT1	1	NAC49TLB	TASK LIGHT BLACK 40 WATTS	\$ 178.00	\$ 70.49	\$ 70.49	60.400
107	NT1	1	31-1866CL MC	ARROWOOD SINGLE STORAGE CABINET LEFT AMBER	\$ 1,481.00	\$ 586.48	\$ 586.48	60.400
108	NT1	1	31-1866CR MC	ARROWOOD SINGLE STORAGE CABINET RIGHT AMBER	\$ 1,481.00	\$ 586.48	\$ 586.48	60.400
109	NT1	1	31-2136FRP MC	LATERAL FILE HPL TOP AMBER	\$ 969.00	\$ 383.72	\$ 383.72	60.400
110	NT1	1	3636MC	VENEER BOOKCASE AMBER FINISH	\$ 404.00	\$ 159.98	\$ 159.98	60.400
111	NT1	1	CCW42RD A W MC	42" ROUND TABLE TOP RADIUS NO GROMMET WOOD AMBER	\$ 1,050.00	\$ 415.80	\$ 415.80	60.400
112	NT1	1	BW-16 MC	CYLINDER BASE WOOD 16W X 27-1/2H AMBER	\$ 724.00	\$ 286.70	\$ 286.70	60.400
113	HST	4	AD10UB MA SG MS 32 12	+Side Chair,Stk,Aside,Uphol Outer Back +metal arms +glide +metallic silver +iota™-Pr Cat 3 +iota™ marsh ice	\$ 322.00	\$ 154.56	\$ 618.24	52.000
114	NT1	1	21-3672RH MC	ARROWOOD RIGHT PEDESTAL DESK FULL PEDESTAL AMBER	\$ 1,027.00	\$ 406.69	\$ 406.69	60.400
115	NT1	1	NAC2421CDL MC	LAMINATE CENTER DRAWER AMBER	\$ 90.00	\$ 35.64	\$ 35.64	60.400
116	NT1	1	21-2448LH MC	ARROWOOD LEFT RETURN FULL PEDESTAL 24X48 AMBER	\$ 626.00	\$ 247.90	\$ 247.90	60.400
117	NT1	1	21-2472SH MC	ARROWOOD STORAGE CREDENZA FULL PEDESTAL AMBER	\$ 1,223.00	\$ 484.31	\$ 484.31	60.400
118	NT1	1	21-1572OSC MC	ARROWOOD HIGHBACK ORGANIZER AMBER	\$ 747.00	\$ 295.81	\$ 295.81	60.400
119	HST	2	AD10UB MA SG MS 32 12	+Side Chair,Stk,Aside,Uphol Outer Back +metal arms +glide +metallic silver +iota™-Pr Cat 3 +iota™ marsh ice	\$ 322.00	\$ 154.56	\$ 309.12	52.000
120	GR3	2	3503S-1-E G4-03 CRE-55	GROUP 4 CONTINUUM SERIES CHAIR (SPLIT SEAT & BACK) EPOXY FRAME ANTIQUE WHITE EPOXY FRAME OLYMPIAD VINYL CRETE CURRANT	\$ 636.00	\$ 298.92	\$ 597.84	53.000
121	GR3	1	3503S-4-E G4-03 CRE-55	GROUP 4 CONTINUUM SERIES LINK CHAIR (SPLIT SEAT & BACK) EPOXY FRAME ANTIQUE WHITE EPOXY FRAME OLYMPIAD VINYL CRETE CURRANT	\$ 614.00	\$ 288.58	\$ 288.58	53.000
122	GR3	1	3503S-3-E G4-03 CRE-55	GROUP 4 CONTINUUM SERIES SOFA (SPLIT SEAT & BACK) EPOXY FRAME ANTIQUE WHITE EPOXY FRAME OLYMPIAD VINYL CRETE CURRANT	\$ 1,578.00	\$ 741.66	\$ 741.66	53.000
123	GR3	1	3503-7-E G4-03 4634 G4-03	GROUP 4 CONTINUUM SERIES LINK CORNER TABLE EPOXY FRAME, PVC EDGE ANTIQUE WHITE EPOXY FRAME STORM NEBULA ANTIQUE WHITE PVC EDGE	\$ 354.00	\$ 166.38	\$ 166.38	53.000

LEE CO. HENDRY ST. 3RD FL: PURCHASING
 F2136.SP4

Item	Cat	Qty	Part Number	Part Description	List \$	Sell \$	Ext Sell \$	Sell- %
124	GR3	1	3503-8-E	GROUP 4 CONTINUUM SERIES COFFEE TABLE EPOXY FRAME, PVC EDGE ANTIQUE WHITE EPOXY FRAME	\$ 542.00	\$ 254.74	\$ 254.74	53.000
			G4-03 4634 G4-03	STORM NEBULA ANTIQUE WHITE PVC EDGE				
125	GU1	35	SUBC-INSTALLATION	TO RECEIVE, DELIVER AND INSTALL SEATING PER STATE OF FLORIDA CONTRACT GUIDELIN...	\$ 10.01	\$ 10.00	\$ 350.00	0.100
126	GU1	1	SUBC-INSTALLATION	TO RECEIVE, DELIVER AND INSTALL PRODUCT	\$ 17,675.01	\$ 17,675.00	\$ 17,675.00	0.000
127	651	32	DESIGN	DESIGN SERVICES SPEC ENTERED 4/10/03 REVISED 4/21/03	\$ 55.01	\$ 55.00	\$ 1,760.00	0.018
				Grand Total			\$ 110,249.00	64.923

**MEMORANDUM
FROM
THE DIVISION OF PURCHASING**

DATE: JUNE 6, 2003

TO: JIM LAVENDER
PUBLIC WORKS DIRECTOR

Janet Sheehan
FROM: JANET SHEEHAN, CPPB
PURCHASING DIRECTOR

RE: BLUE SHEET # 20030685

PROJECT: Furniture for Development Services/Inspector Building

TYPE: State Contract Purchase

AWARDED TO: Herman Miller Workplace

When you have finished your review of this package, please forward it to Kristie Kroslack in the County Attorney's Office.

If there are any questions or concerns with this package, please contact Patti Armbruster at 689-7385.