

C:\Users\tonya\OneDrive\Documents\CLEAN LINES\Urban Green Studio\LittletonExtension\Construction Docs\Littleton-Extension.dwg, 4/28/2023 9:25:26 AM

LEE COUNTY
DEPARTMENT OF TRANSPORTATION
CONTRACT PLANS
FINANCIAL PROJECT ID 442000-1-54-01

**LITTLETON / KISMET REALIGNMENT
FROM NE 24TH AVENUE TO CORBETT ROAD
(County Project No. CN190114)
LANDSCAPE AND IRRIGATION PLANS**

SHEET INDEX

CVR	COVER SHEET
LA-1	LANDSCAPE PLAN
LA-2	LANDSCAPE PLAN
LA-3	LANDSCAPE PLAN
LA-4	LANDSCAPE PLAN
LA-5	LANDSCAPE PLAN
LA-6	LANDSCAPE PLAN
LA-7	SIGHTLINE DIAGRAMS
LA-8	SIGHTLINE DIAGRAMS
LA-9	LANDSCAPE DETAILS
LA-10	LANDSCAPE DETAILS
LA-11	LANDSCAPE SPECIFICATIONS
LA-12	PLANT SCHEDULE

SHEET INDEX

IR-M	IRRIGATION MASTER PLAN
IR-1	IRRIGATION PLAN
IR-2	IRRIGATION PLAN
IR-3	IRRIGATION PLAN
IR-4	IRRIGATION PLAN
IR-5	IRRIGATION PLAN
IR-6	IRRIGATION PLAN
IR-7	IRRIGATION DETAILS & NOTES
IR-8	IRRIGATION DETAILS & NOTES
IR-9	IRRIGATION DETAILS & NOTES
IR-10	IRRIGATION DETAILS & NOTES
IR-11	IRRIGATION DETAILS & NOTES
IR-12	IRRIGATION DETAILS & NOTES
IR-13	IRRIGATION NOTES
IR-14	IRRIGATION NOTES
IR-15	IRRIGATION LEGEND

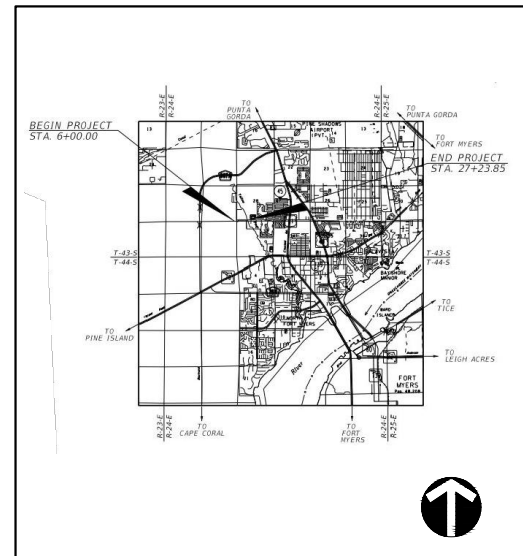

PROJECT LOCATION MAP

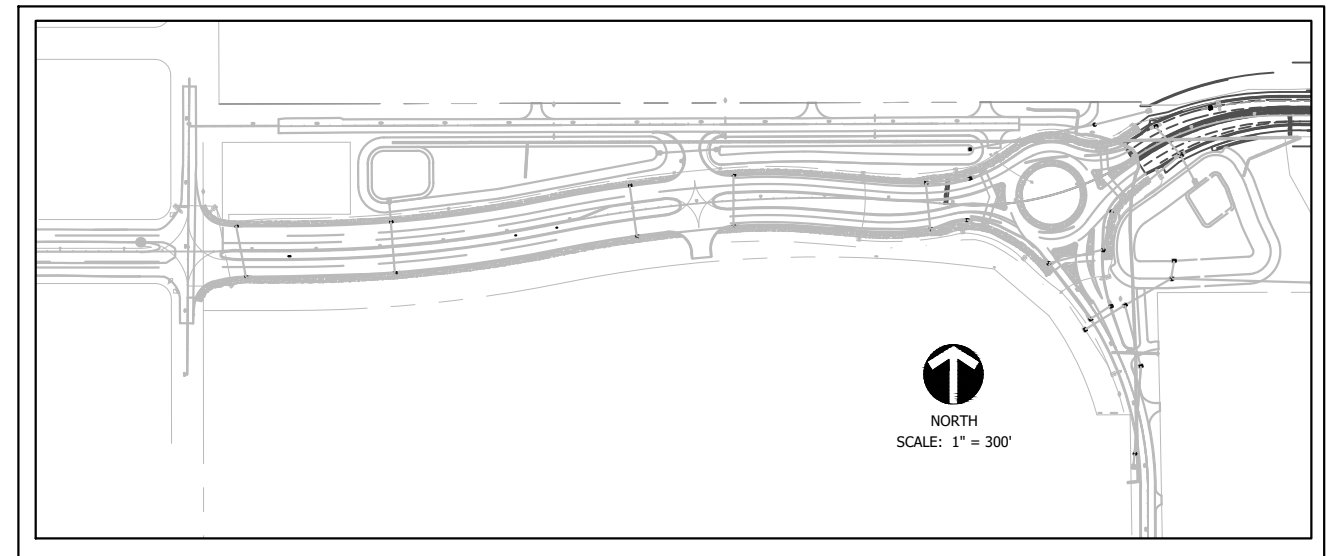

OVERALL SITE MAP

UTILITY PROVIDERS:

LEE COUNTY UTILITIES
(WATER AND SEWER)
1500 MONROE STREET
FORT MYERS, FL 33901
239.533.8181

LEE COUNTY PORT AUTHORITY ARFF
(FIRE RESCUE)
11901 REGIONAL LANE
FORT MYERS, FL 33913
239.590.4716

LEE COUNTY TRAFFIC
5642 ENTERPRISE PARKWAY
FORT MYERS, FL 33905
239.533.9300

FPL
15834 WINKLER ROAD
FORT MYERS, FL 33908
239.415.4319

CENTURYLINK
2820 CARGO STREET
FORT MYERS, FL 33916
239.336.2035

COMCAST
12641 CORPORATE LAKES DRIVE
FORT MYERS, FL 33913
239.432.1805

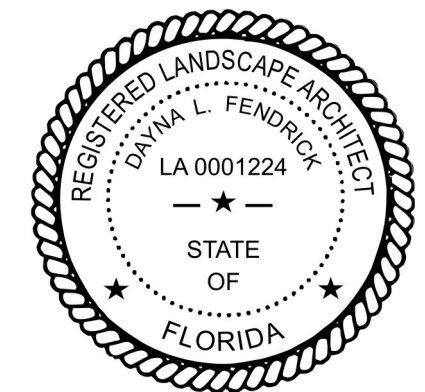

P.O. BOX 111841, NAPLES, FLORIDA 34108
PHONE (239) 263-4029 FAX (239) 594-7091

IN COORDINATION WITH:
Stantec
1821 VICTORIA AVENUE
FORT MYERS, FL 33901

PREPARED FOR:
LEE COUNTY
DEPARTMENT OF
TRANSPORTATION

LITTLETON ROAD
CONTRACT NO.: CN190114
LEE COUNTY, FL

SCALE:		
DATE:	DECEMBER 2021	
PROJECT #:		
REV	DATE	DESCRIPTION

COVER SHEET

SHEET #
CVR

DAYNA L. FENDRICK, RLA #0001224

C:\Users\tonya\OneDrive\Documents\CLEAN LINES\Urban Green Studio\LittletonExtension\Construction Docs\Littleton-Extension.dwg, 4/28/2023 9:26:24 AM

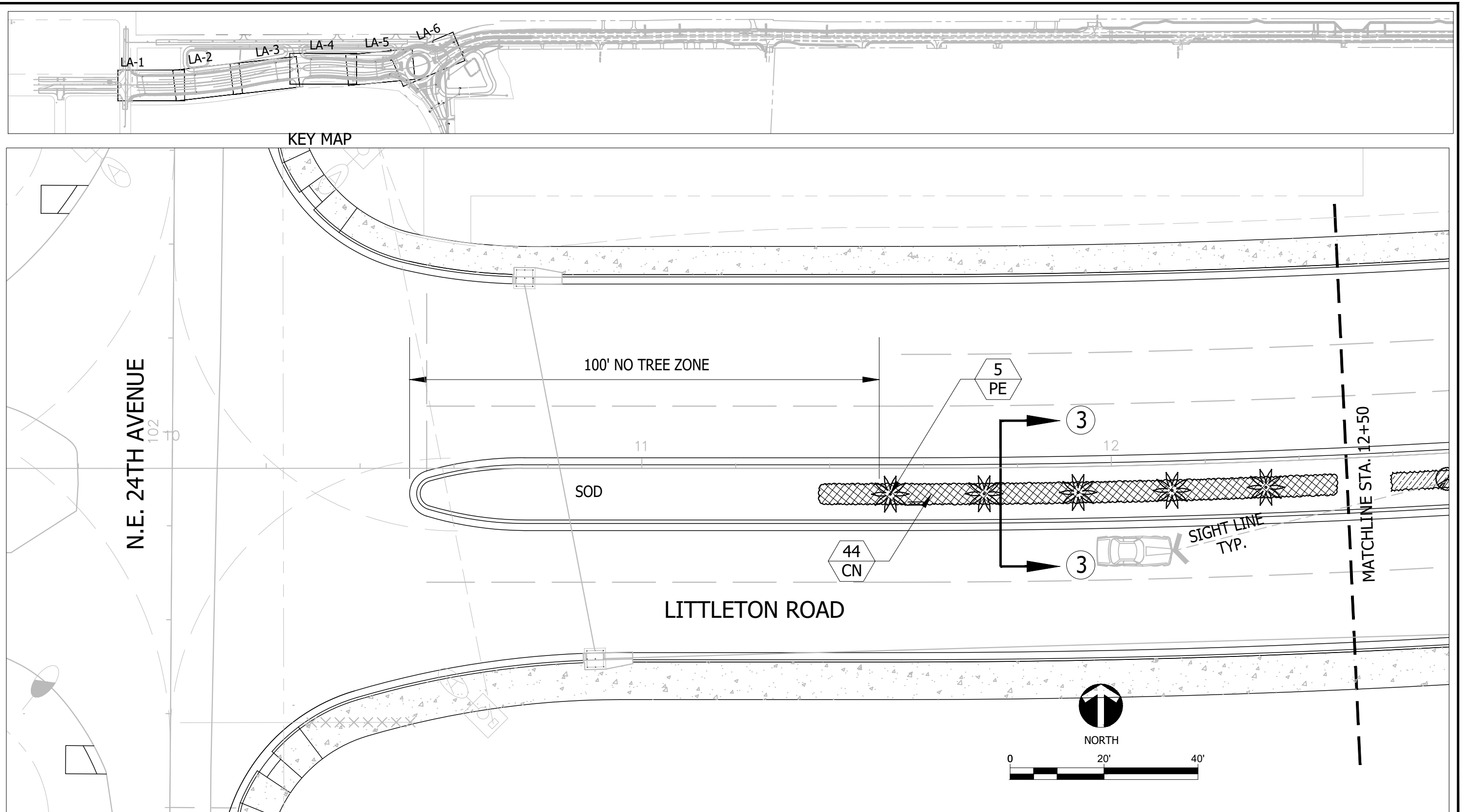

P.O. BOX 111841, NAPLES, FLORIDA 34108
PHONE (239) 263-4029 FAX (239) 594-7091

IN COORDINATION WITH:
Stantec
1821 VICTORIA AVENUE
FORT MYERS, FL 33901

PREPARED FOR:
LEE COUNTY
DEPARTMENT OF
TRANSPORTATION

LITTLETON ROAD
CONTRACT NO.: CN190114
LEE COUNTY, FL

REV	DATE	DESCRIPTION

SCALE: 1" = 20'
DATE: DECEMBER 2021
PROJECT #:

LANDSCAPE PLAN

DAYNA L. FENDRICK, RLA #0001224

SHEET #
LA-1

C:\Users\tonya\OneDrive\Documents\CLEAN LINES\Urban Green Studio\LittletonExtension\Construction Docs\Littleton-Extension.dwg, 4/28/2023 9:25:39 AM

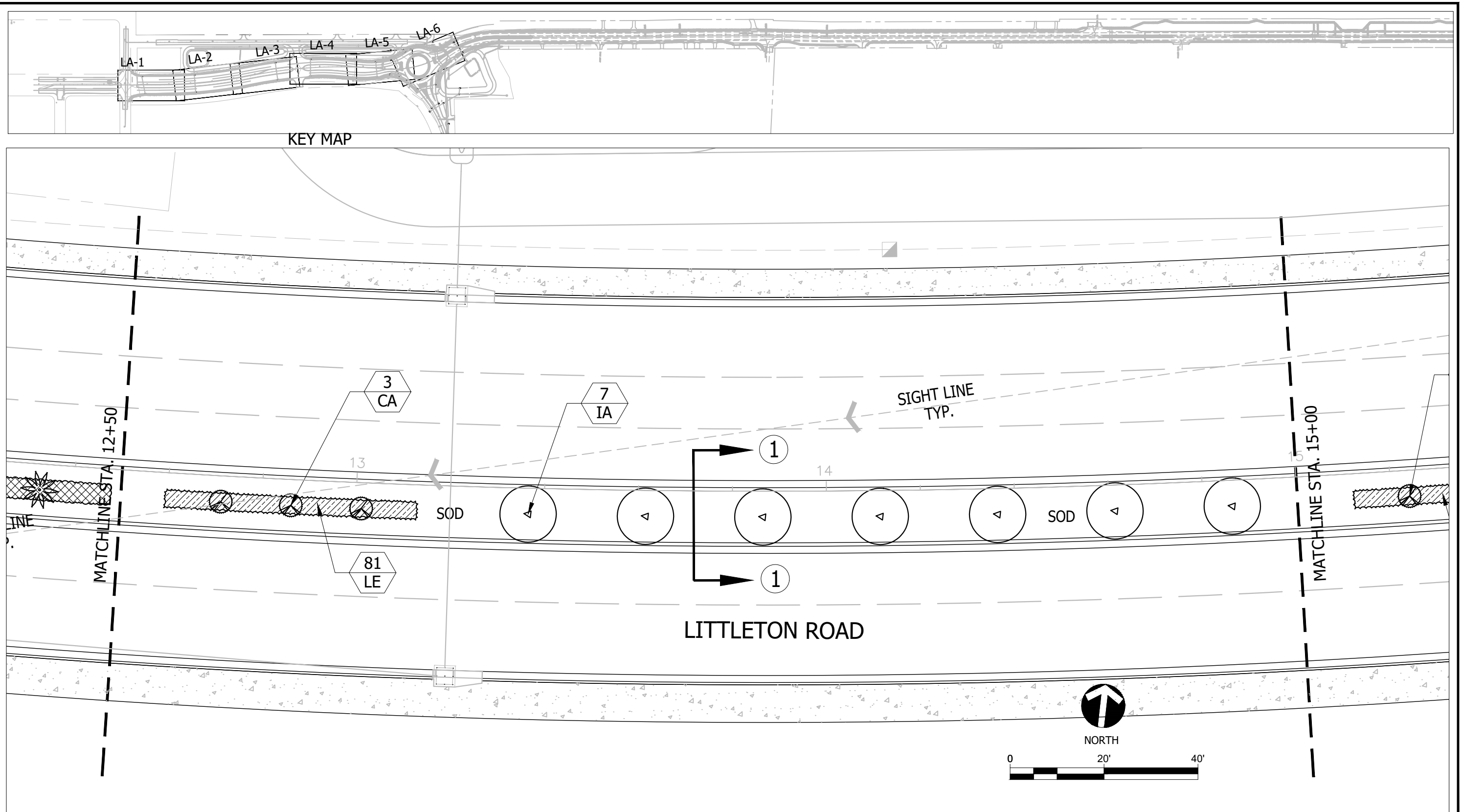

IN COORDINATION WITH:
Stantec
 1821 VICTORIA AVENUE
 FORT MYERS, FL 33901

PREPARED FOR:
 LEE COUNTY
 DEPARTMENT OF
 TRANSPORTATION

LITTLETON ROAD
 CONTRACT NO.: CN190114
 LEE COUNTY, FL

REV	DATE	DESCRIPTION

SCALE: 1" = 20'
 DATE: DECEMBER 2021
 PROJECT #:

LANDSCAPE PLAN

DAYNA L. FENDRICK, RLA #0001224

SHEET #
LA-2

C:\Users\tonya\OneDrive\Documents\CLEAN LINES\Urban Green Studio\LittletonExtension\Construction Docs\Littleton-Extension.dwg, 4/28/2023 9:25:55 AM

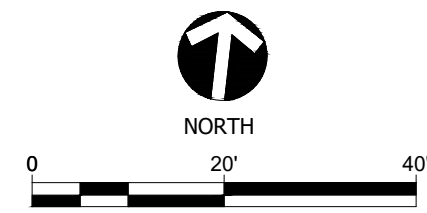
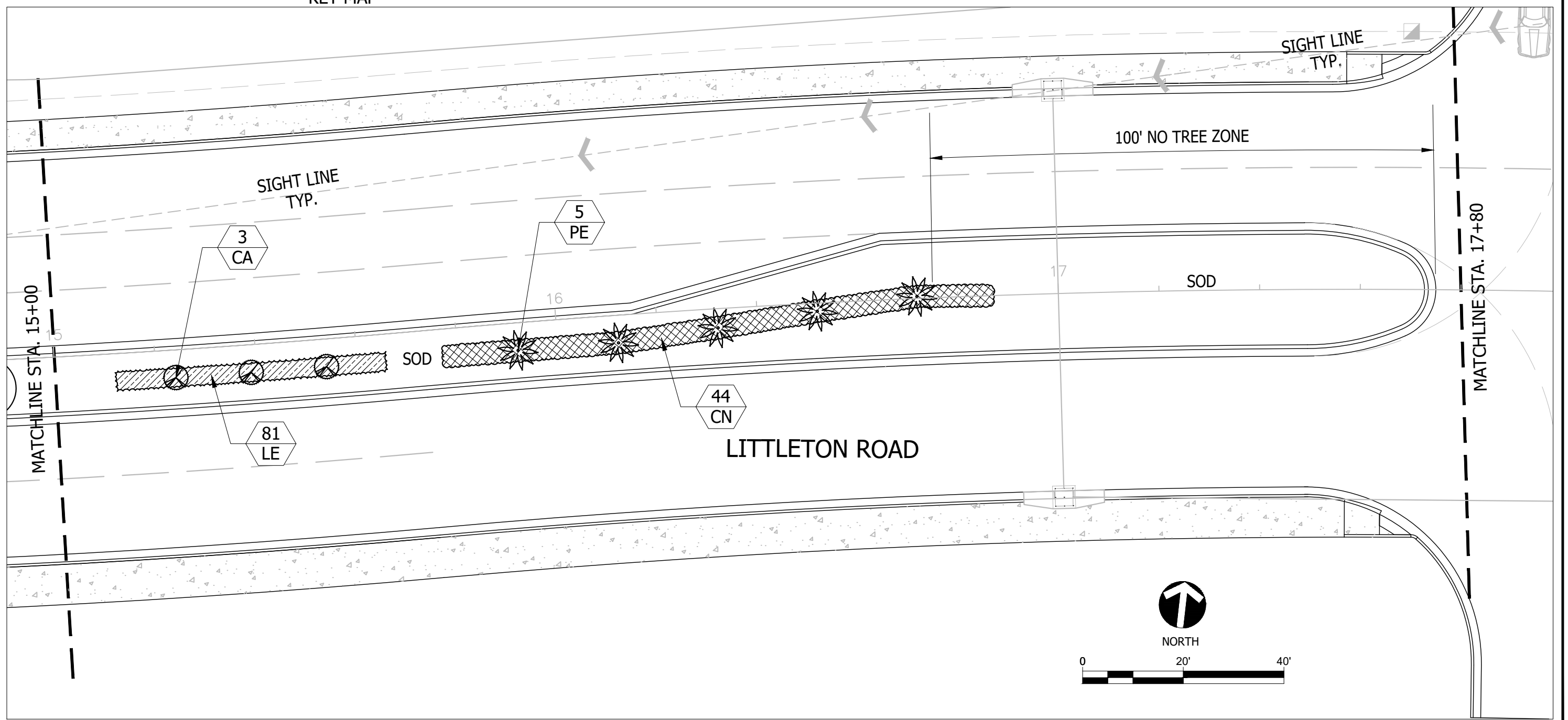
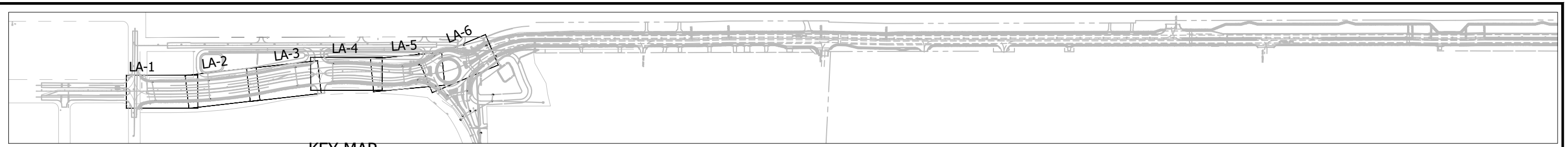

IN COORDINATION WITH:
Stantec
 1821 VICTORIA AVENUE
 FORT MYERS, FL 33901

PREPARED FOR:
 LEE COUNTY
 DEPARTMENT OF
 TRANSPORTATION

LITTLETON ROAD
 CONTRACT NO.: CN190114
 LEE COUNTY, FL

REV	DATE	DESCRIPTION

SCALE: 1" = 20'
 DATE: DECEMBER 2021
 PROJECT #:

LANDSCAPE PLAN

DAYNA L. FENDORICK, RLA #0001224

SHEET #
LA-3

C:\Users\tonya\OneDrive\Documents\CLEAN LINES\Urban Green Studio\LittletonExtension\Construction Docs\Littleton-Extension.dwg, 4/28/2023 9:26:07 AM

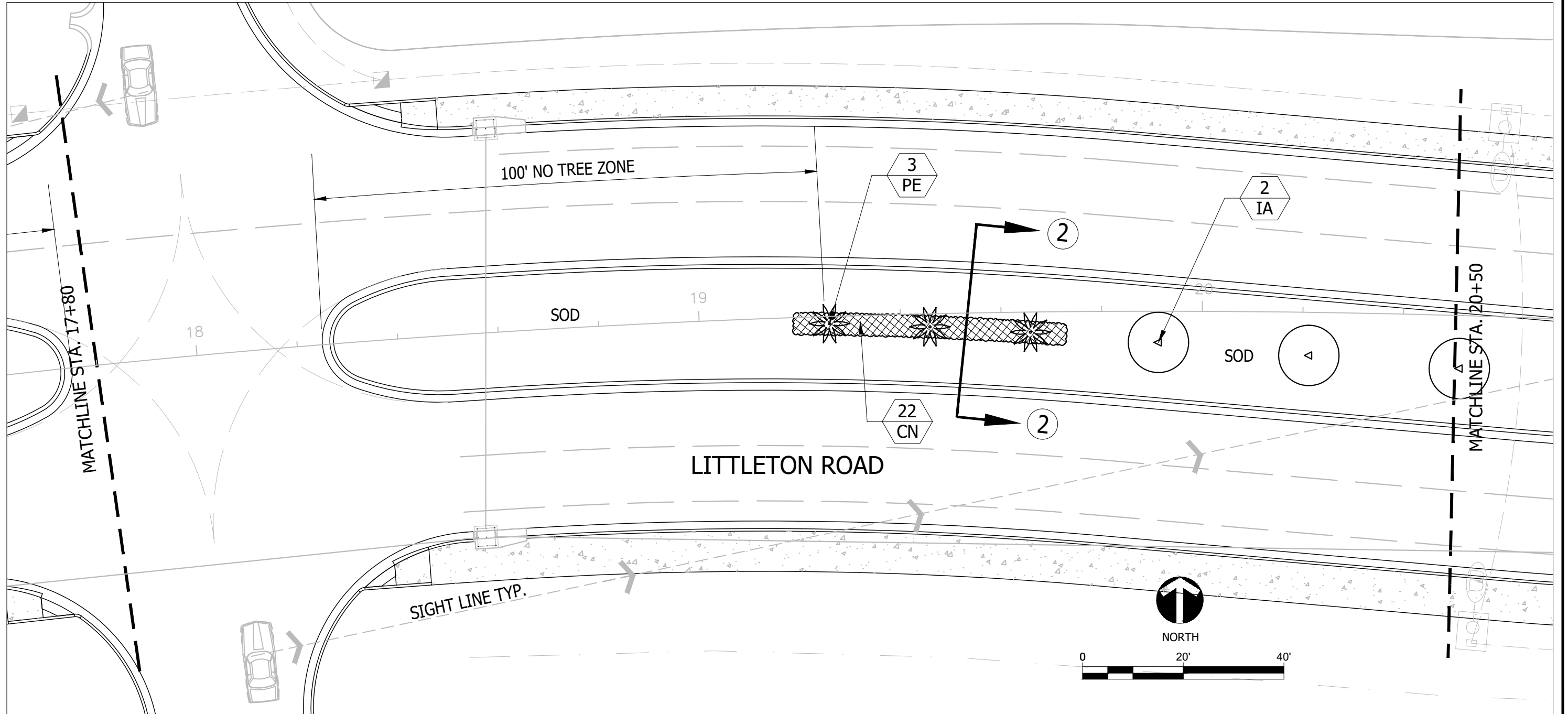
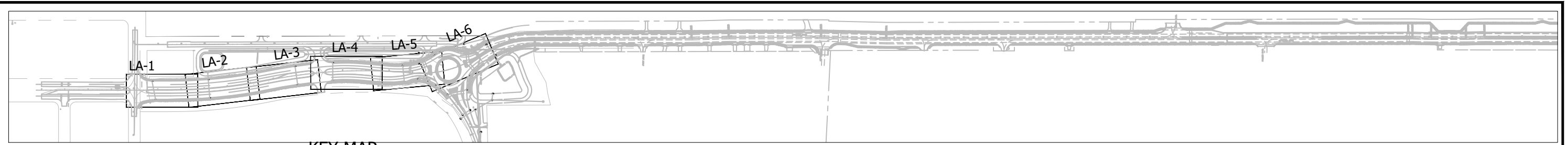

P.O. BOX 111841, NAPLES, FLORIDA 34108
PHONE (239) 263-4629 FAX (239) 594-7091

IN COORDINATION WITH:
Stantec
1821 VICTORIA AVENUE
FORT MYERS, FL 33901

PREPARED FOR:
LEE COUNTY
DEPARTMENT OF
TRANSPORTATION

LITTLETON ROAD
CONTRACT NO.: CN190114
LEE COUNTY, FL

REV	DATE	DESCRIPTION

SCALE: 1" = 20'
DATE: DECEMBER 2021
PROJECT #:

LANDSCAPE PLAN

SHEET #
LA-4

DAYNA L. FENDRICK, RLA #0001224

C:\Users\tonya\OneDrive\Documents\CLEAN LINES\Urban Green Studio\LittletonExtension\Construction Docs\Littleton-Extension.dwg, 4/28/2023 9:25:32 AM

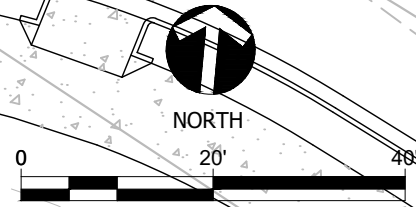
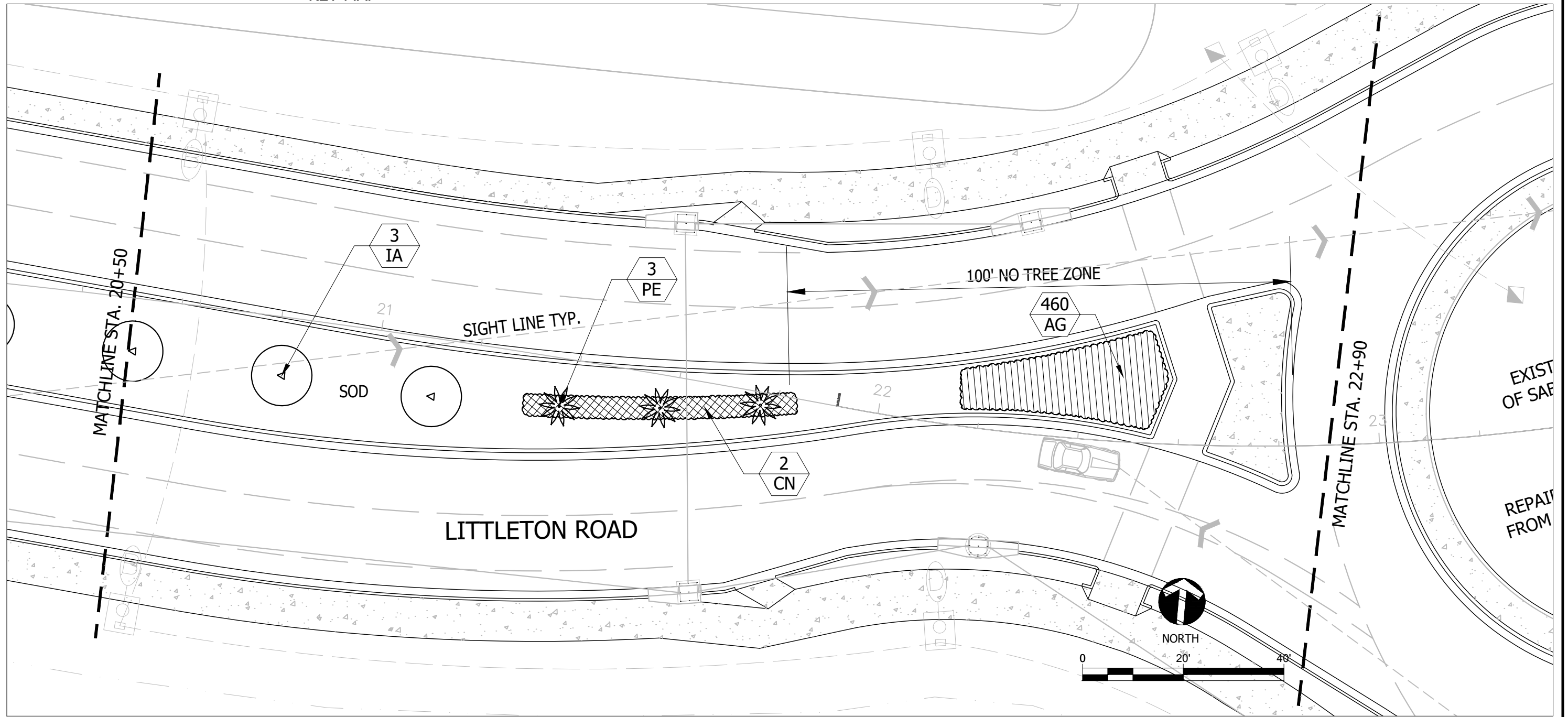
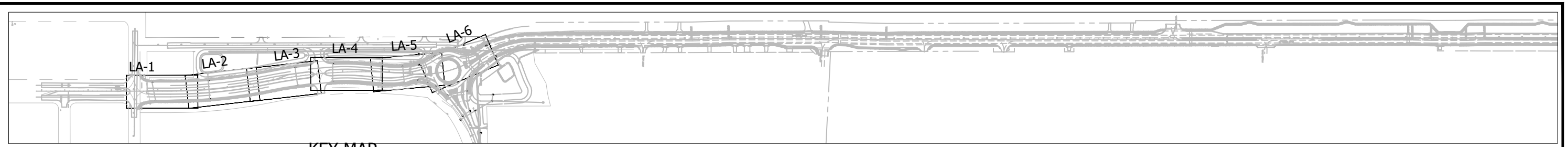

IN COORDINATION WITH:
Stantec
1821 VICTORIA AVENUE
FORT MYERS, FL 33901

PREPARED FOR:
LEE COUNTY
DEPARTMENT OF
TRANSPORTATION

LITTLETON ROAD
CONTRACT NO.: CN190114
LEE COUNTY, FL

REV	DATE	DESCRIPTION

SCALE: 1" = 20'
DATE: DECEMBER 2021
PROJECT #:

LANDSCAPE PLAN

SHEET #
LA-5

DAYNA L. FENDORICK, RLA #0001224

C:\Users\tonya\OneDrive\Documents\CLEAN LINES\Urban Green Studio\LittletonExtension\Construction Docs\Littleton-Extension.dwg, 4/28/2023 9:26:44 AM

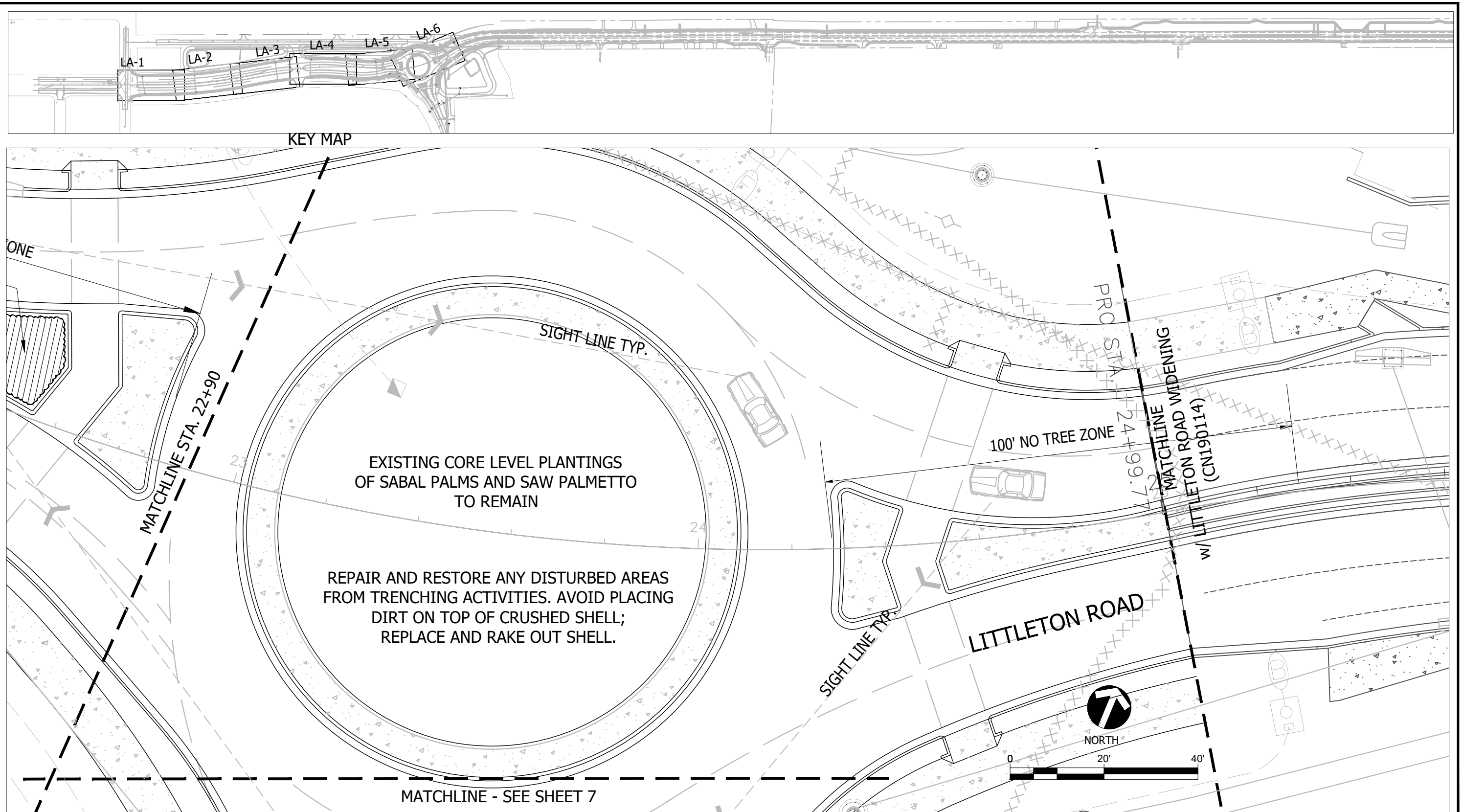

P.O. BOX 111841, NAPLES, FLORIDA 34108
PHONE (239) 263-4029 FAX (239) 594-7091

IN COORDINATION WITH:
Stantec
1821 VICTORIA AVENUE
FORT MYERS, FL 33901

PREPARED FOR:
LEE COUNTY
DEPARTMENT OF
TRANSPORTATION

LITTLETON ROAD
CONTRACT NO.: CN190114
LEE COUNTY, FL

REV	DATE	DESCRIPTION

SCALE: 1" = 20'
DATE: DECEMBER 2021
PROJECT #:

LANDSCAPE PLAN

DAYNA L. FENDRICK, RLA #0001224

SHEET #
LA-6

C:\Users\tonya\OneDrive\Documents\CLEAN LINES\Urban Green Studio\LittletonExtension\Construction Docs\Littleton-Extension.dwg, 4/28/2023 9:26:31 AM

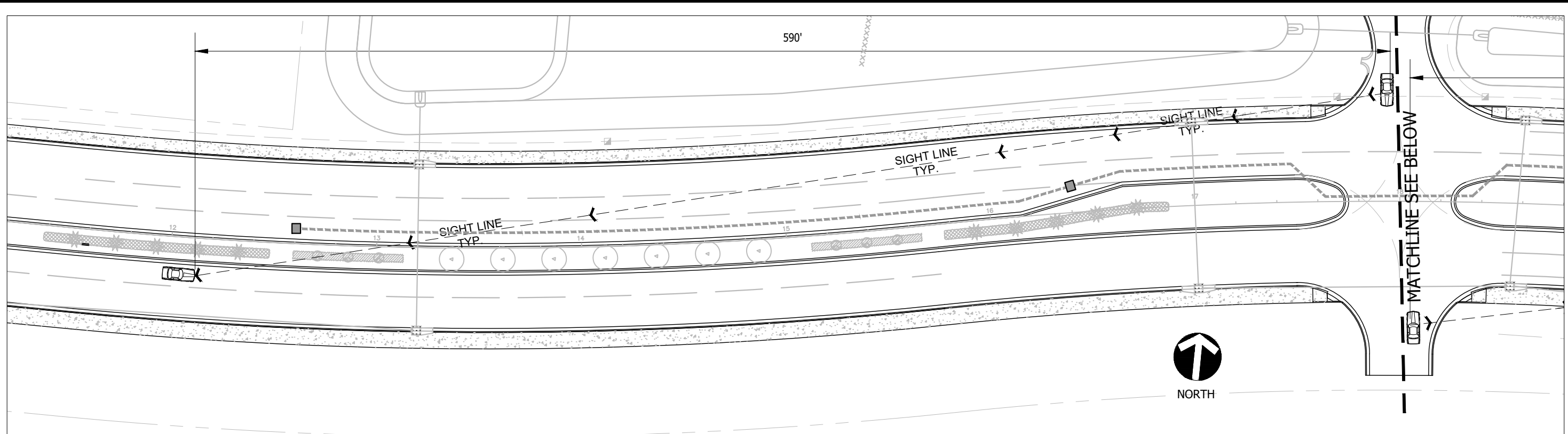

SIGHTLINE AT OLD LITTLETON INTERSECTION

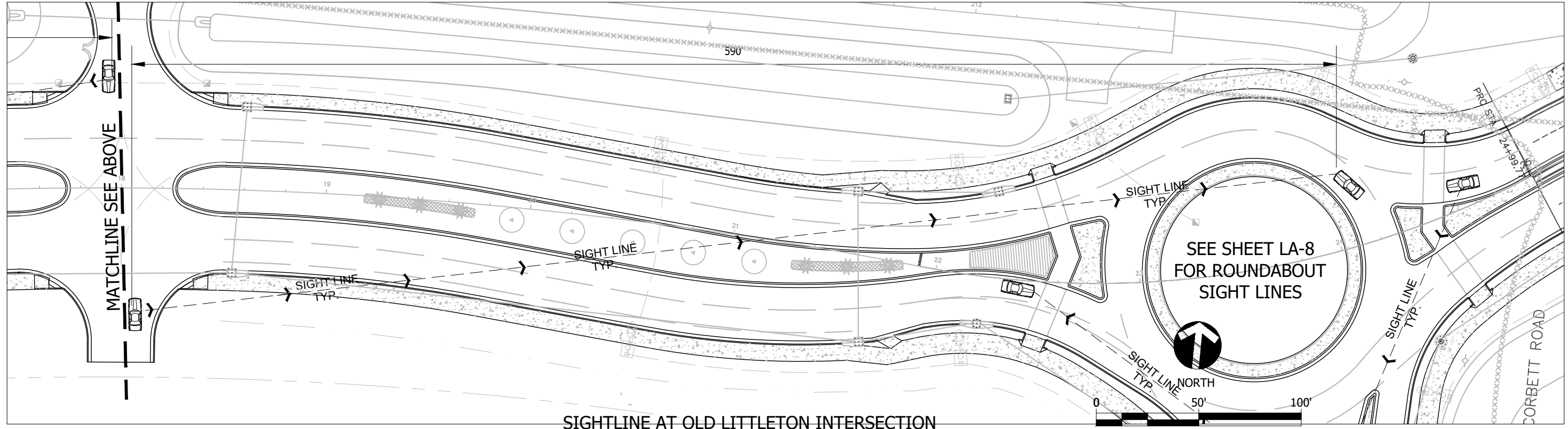

SIGHTLINE AT OLD LITTLETON INTERSECTION



IN COORDINATION WITH:
Stantec
 1821 VICTORIA AVENUE
 FORT MYERS, FL 33901

PREPARED FOR:
 LEE COUNTY
 DEPARTMENT OF
 TRANSPORTATION

LITTLETON ROAD
 CONTRACT NO.: CN190114
 LEE COUNTY, FL

SCALE:	1" = 50'	
DATE:	DECEMBER 2021	
PROJECT #:		
REV	DATE	DESCRIPTION

SIGHTLINE DIAGRAMS

SHEET #
LA-7

DAYNA L. FENDORICK, RLA #0001224

C:\Users\tonya\OneDrive\Documents\CLEAN LINES\Urban Green Studio\LittletonExtension\Construction Docs\Littleton-Extension.dwg, 4/28/2023 9:26:12 AM

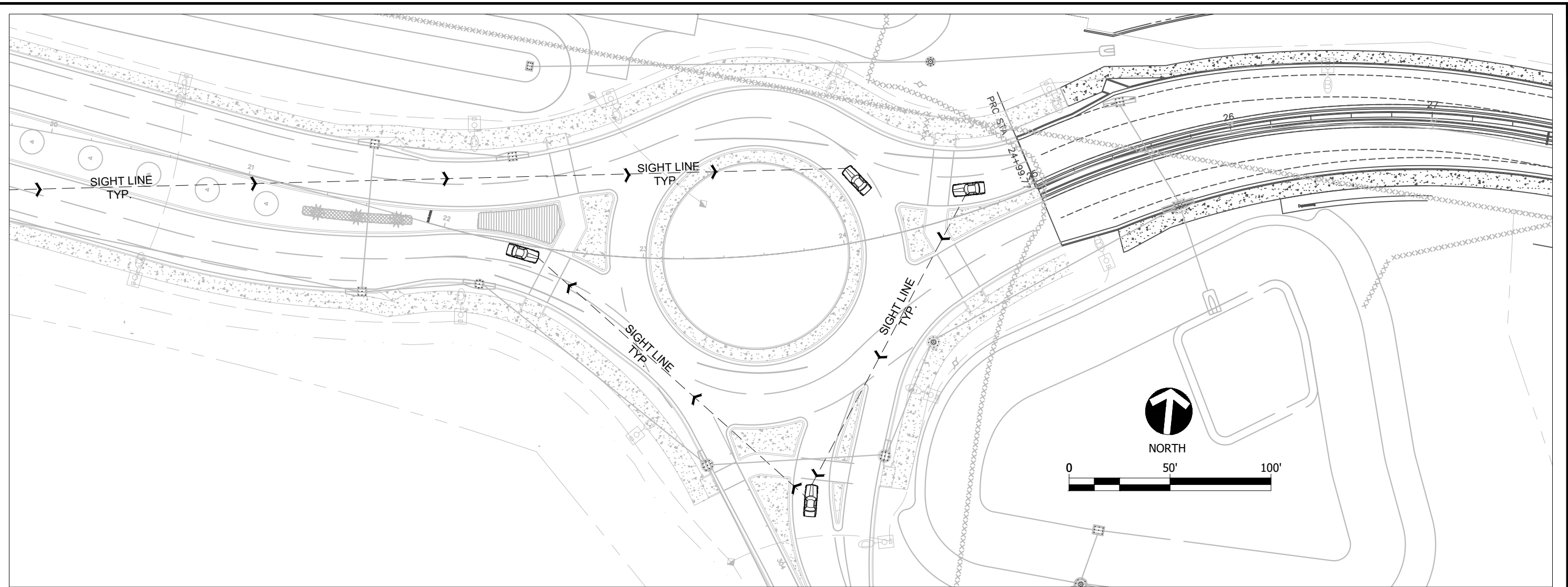

SIGHTLINE AT CORBETT ROAD INTERSECTION



P.O. BOX 111841, NAPLES, FLORIDA 34108
PHONE (239) 263-4629 FAX (239) 594-7091

IN COORDINATION WITH:
Stantec
1821 VICTORIA AVENUE
FORT MYERS, FL 33901

PREPARED FOR:
LEE COUNTY
DEPARTMENT OF
TRANSPORTATION

LITTLETON ROAD
CONTRACT NO.: CN190114
LEE COUNTY, FL

REV	DATE	DESCRIPTION

SCALE: 1" = 50'
DATE: DECEMBER 2021
PROJECT #:

SIGHTLINE DIAGRAMS

DAYNA L. FENDORICK, RLA #0001224

SHEET #
LA-8

C:\Users\tonya\OneDrive\Documents\CLEAN LINES\Urban Green Studio\LittletonExtension\Construction Docs\Littleton-Extension.dwg, 4/28/2023 9:25:46 AM

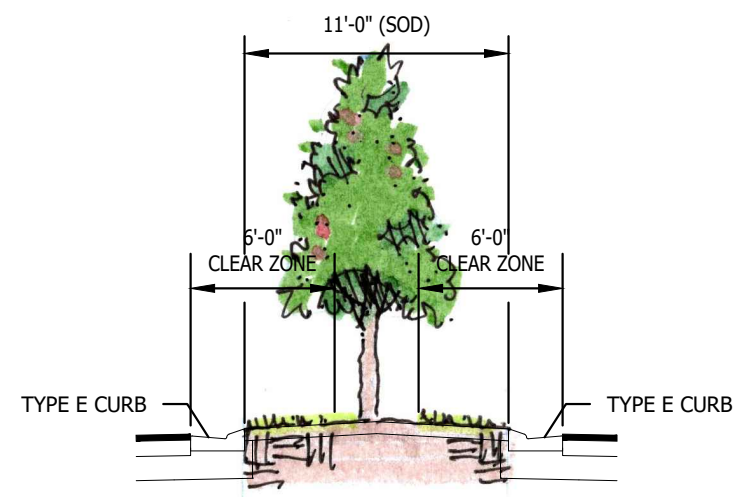

TYPICAL MEDIAN SECTION 1
SCALE: 1/8" = 1'-0"

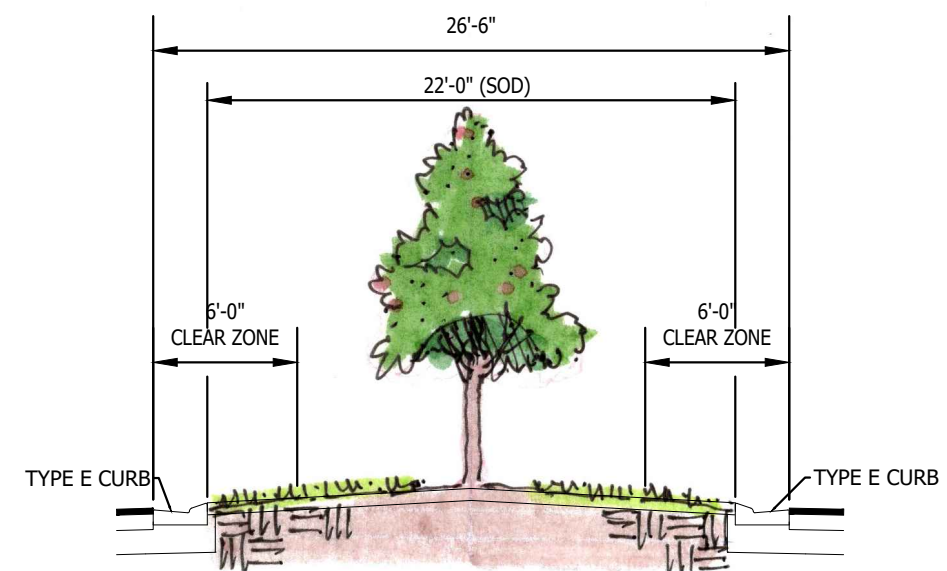

TYPICAL MEDIAN SECTION 2
SCALE: 1/8" = 1'-0"

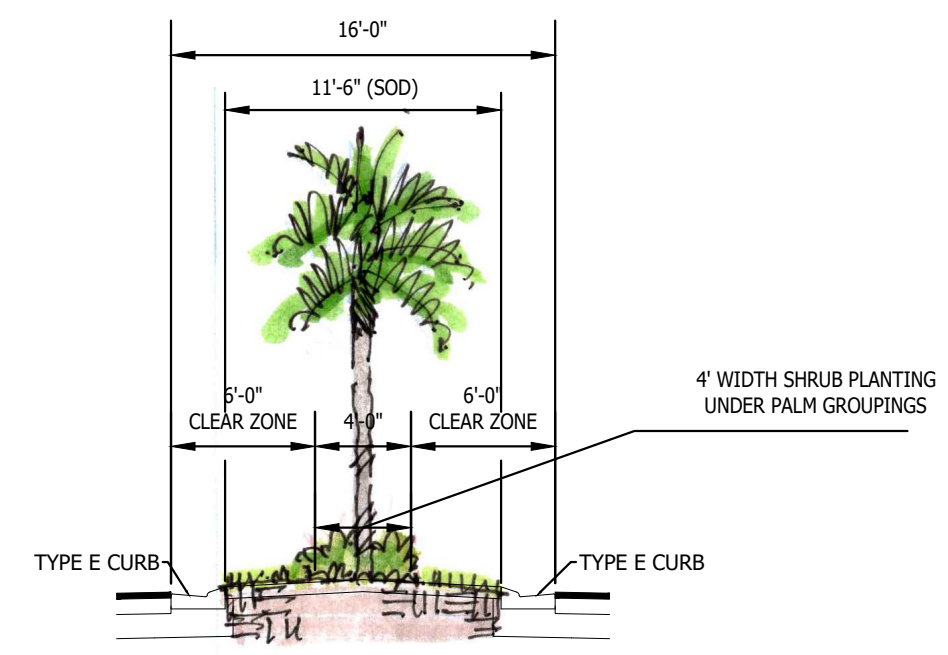

TYPICAL MEDIAN SECTION 3
SCALE: 1/8" = 1'-0"

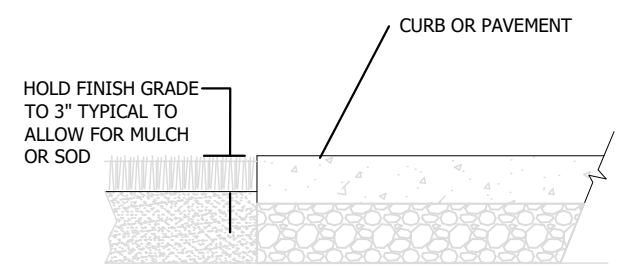

SOD/MULCH AT PAVEMENT EDGE
N.T.S.

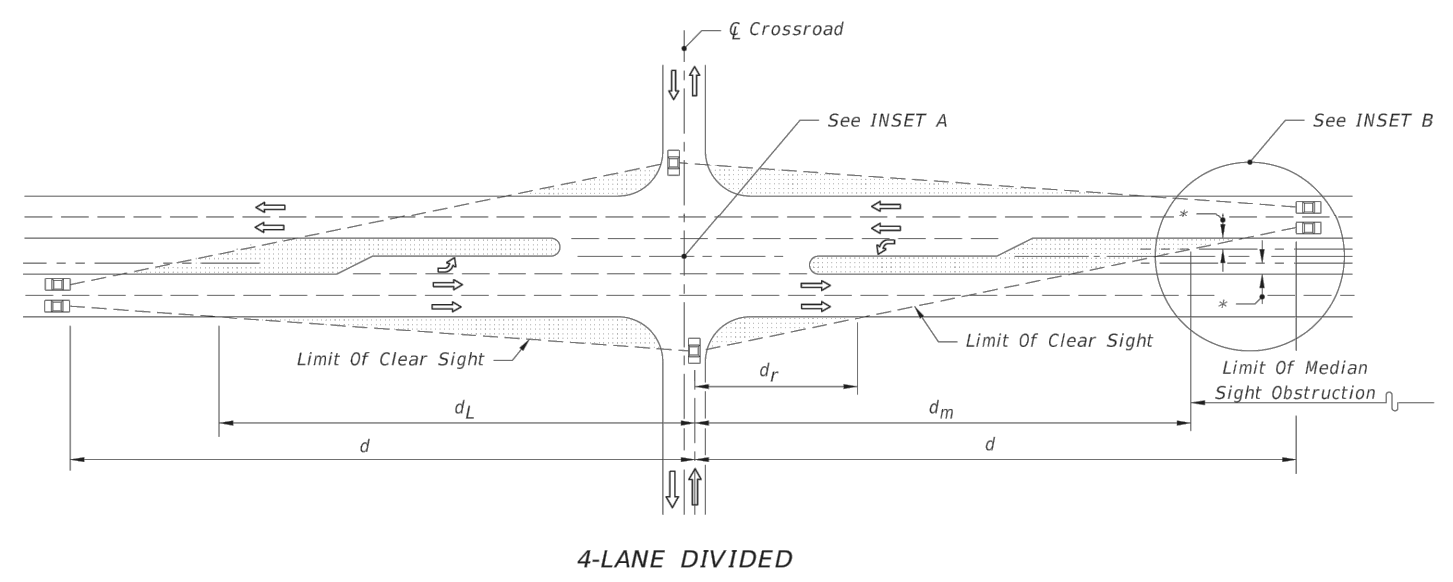

FDOT SIGHT DISTANCE GRAPHIC
N.T.S.

Median 22' or Less				
Design Speed (mph)	d (Ft.)	d _L (Ft.)	d _R (Ft.)	d _M (Ft.)
30	395	280	90	325
35	460	325	100	380
40	525	375	115	430
45	590	420	130	485
50	655	465	145	540
55	720	510	160	590
60	785	555	175	645
65	850	605	185	700

Passenger Vehicle

BASED ON 45 MPH DESIGN SPEED, SIGHT DISTANCE IS 590'.



IN COORDINATION WITH:
Stantec
1821 VICTORIA AVENUE
FORT MYERS, FL 33901

PREPARED FOR:
LEE COUNTY
DEPARTMENT OF
TRANSPORTATION

LITTLETON ROAD
CONTRACT NO.: CN190114
LEE COUNTY, FL

SCALE:	1" = 40'	
DATE:	DECEMBER 2021	
PROJECT #:		
REV	DATE	DESCRIPTION

LANDSCAPE DETAILS

DAYNA L. FENDORICK, RLA #0001224

SHEET #
LA-9

C:\Users\tonya\OneDrive\Documents\CLEAN LINES\Urban Green Studio\LittletonExtension\Construction Docs\Littleton-Extension.dwg, 4/28/2023 9:26:01 AM

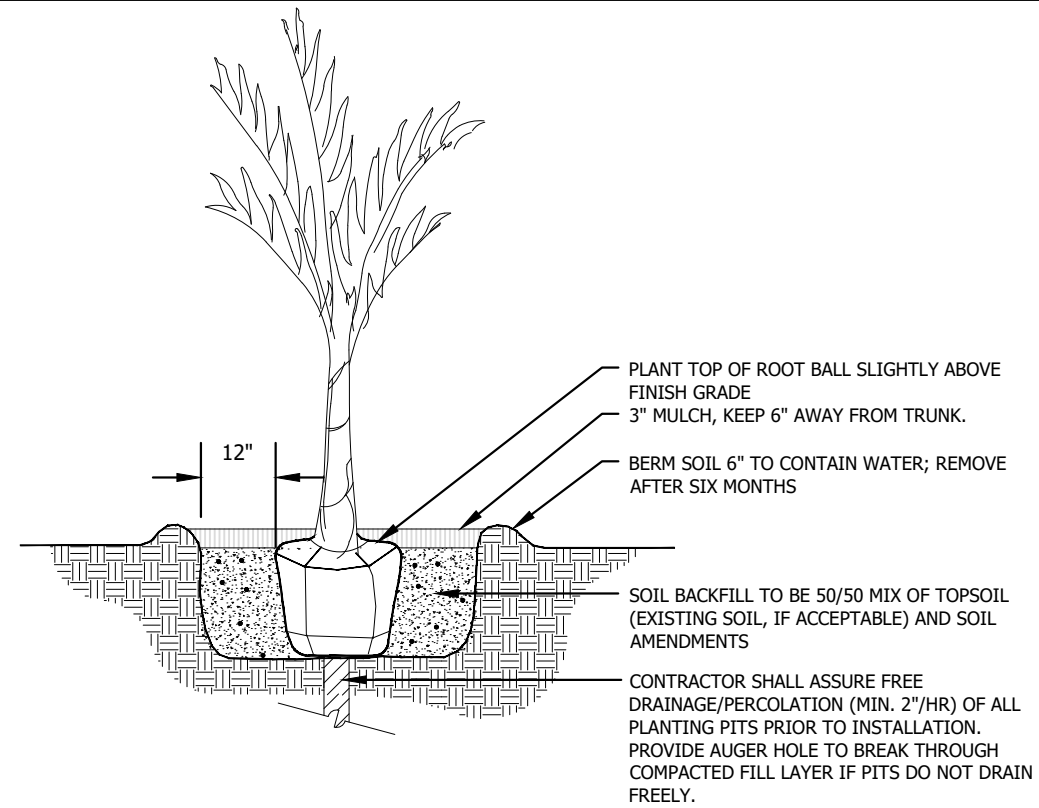

SLENDER PALM INSTALLATION AND MAINTENANCE
N.T.S.

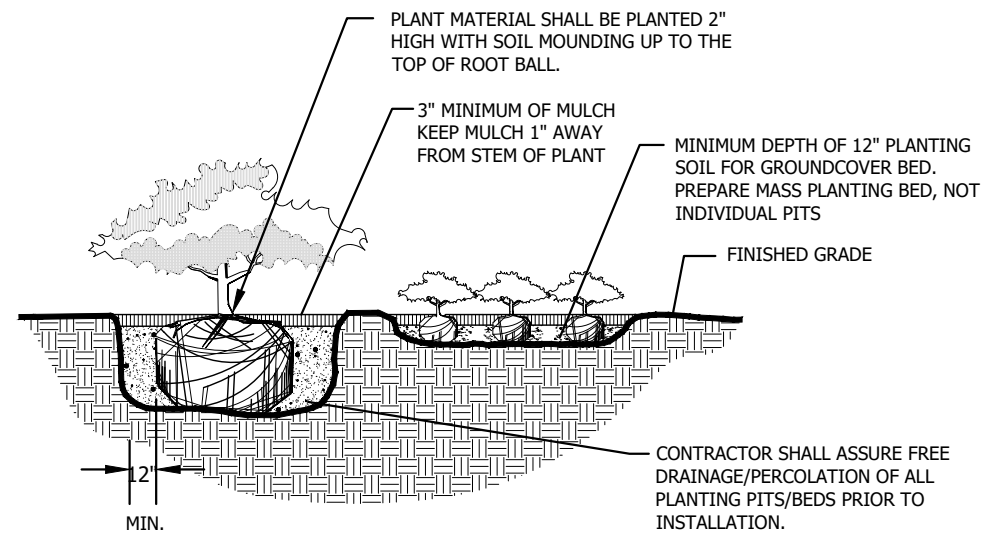

SHRUBS AND GROUNDCOVER
N.T.S.

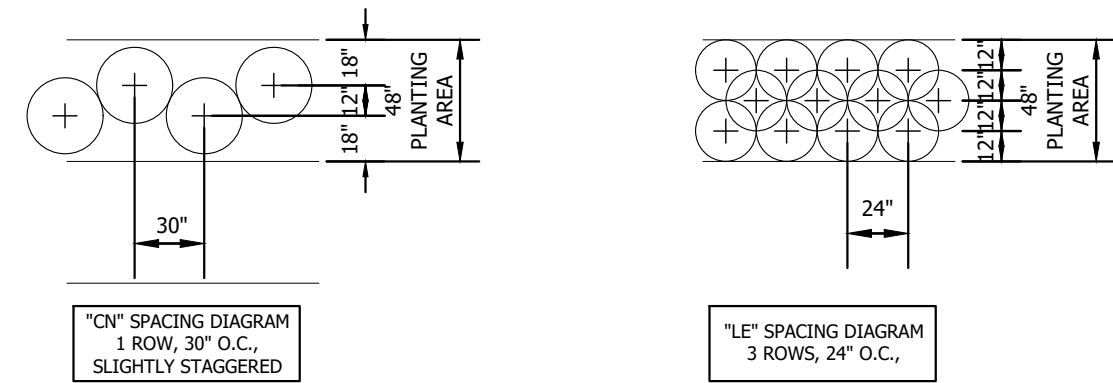

TYPICAL PLANT SPACING
N.T.S.



IN COORDINATION WITH:
Stantec
1821 VICTORIA AVENUE
FORT MYERS, FL 33901

PREPARED FOR:
LEE COUNTY
DEPARTMENT OF
TRANSPORTATION

LITTLETON ROAD
CONTRACT NO.: CN190114
LEE COUNTY, FL

REV	DATE	DESCRIPTION

SCALE:
DATE: DECEMBER 2021
PROJECT #:

LANDSCAPE DETAILS

DAYNA L. FENDORICK, RLA #0001224

SHEET #
LA-10

C:\Users\tonya\OneDrive\Documents\CLEAN LINES\Urban Green Studio\LittletonExtension\Construction Docs\Littleton-Extension.dwg, 4/28/2023 9:26:18 AM

SPECIFICATIONS

GENERAL

- PRIOR TO CONSTRUCTION, THE LANDSCAPE CONTRACTOR IS RESPONSIBLE FOR CONTACTING SUNSHINE ONE (CALL 811, OR TOLL FREE 800-432-4770), LOCATING ALL UNDERGROUND UTILITIES AND SHALL AVOID DAMAGE TO ALL UTILITIES DURING CONSTRUCTION. SHOULD THE LANDSCAPE CONTRACTOR CAUSE DAMAGE TO ANY UTILITIES, NECESSARY REPAIRS SHALL BE MADE AS QUICKLY AS PRACTICABLE, AT LANDSCAPE CONTRACTOR'S EXPENSE.
- THE CONTRACTOR IS RESPONSIBLE FOR OBTAINING ALL NECESSARY PERMITS NOT PROVIDED FOR BY THE OWNER PRIOR TO COMMENCING ANY WORK.
- THE CONTRACTOR IS RESPONSIBLE FOR TESTING THE pH OF THE WELL WATER PRIOR TO SOIL PREPARATION.
- THE CONTRACTOR IS RESPONSIBLE FOR KEEPING A FULL SIGNED AND SEALED PLAN SET ON SITE AT ALL TIMES. THE CONTRACTOR SHALL MAINTAIN A REDLINED COPY OF ALL FIELD ADJUSTMENTS MADE, AND PROVIDE A COPY OF THE REDLINED PLANS TO THE LANDSCAPE ARCHITECT FOR PREPARING THE AS-BUILT PLANS AT THE COMPLETION OF THE JOB.
- THE CONSTRUCTION BID PRICES FOR ITEMS THAT REQUIRE DEMOLITION AND/OR REMOVAL OF EXISTING MATERIALS SHALL INCLUDE THE COST OF DEMOLITION AND PROPER DISPOSAL OF THE EXISTING MATERIALS, SUCH AS PLANTINGS, ASPHALT, LIMESTONE, FILL DIRT, AND CONCRETE.
- THE CONTRACTOR IS RESPONSIBLE FOR MAINTAINING, IN FULL ALL PLANTING AREAS (INCLUDING WATERING, SPRAYING, MULCHING, MOWING, FERTILIZING, ETC.) UNTIL THE JOB IS ACCEPTED BY THE OWNER AND LANDSCAPE ARCHITECT.
- ALL PLANT MATERIAL SHALL BE OF FLORIDA NO. 1 OR BETTER QUALITY AT TIME OF INSTALLATION AND SHALL BE MAINTAINED IN THIS SAME CONDITION UNTIL FINAL ACCEPTANCE. DECLINE IN CONDITION OF PLANT MATERIAL DURING THE MAINTENANCE PERIOD SHALL BE GROUNDS FOR REJECTION AND REPLACEMENT.
- SAMPLES OF ALL PLANT AND HARDSCAPE MATERIAL TO BE SUBMITTED FOR OWNER AND/OR LANDSCAPE ARCHITECT APPROVAL PRIOR TO INSTALLATION.
- ALL QUANTITIES INDICATED ON THE PLANS ARE INTENDED AS A GUIDE FOR THE BIDDER AND DOES NOT RELIEVE THE BIDDER OF HIS RESPONSIBILITY TO DO A COMPREHENSIVE PLANT QUANTITY TAKE OFF. IN THE CASE OF A CONFLICT BETWEEN THE DRAWINGS AND THE BID FORM, THE DRAWINGS SHALL GOVERN.
- AFTER RECEIPT OF BIDS, PRICES FOR ANY QUANTITIES ADDED TO OR DELETED FROM THE BID SCHEDULE BY THE LANDSCAPE ARCHITECT WILL BE BASED ON THE UNIT PRICE SCHEDULE SUBMITTED BY CONTRACTOR.

MEDIAN GRADING AND SOIL PREPARATION SPECIFICATIONS:

- IF ANY LIMEROCK BASE MATERIAL, ROCK, OR OTHER DELETERIOUS MATERIALS ARE ENCOUNTERED DURING GRADING, IRRIGATION, OR PLANTING, THOSE MATERIALS MUST BE REMOVED AND DISPOSED OF OFF-SITE. ANY COMPACTED FILL OR SUBGRADE MUST BE PIERCED THROUGH COMPLETELY TO ALLOW FOR PERCOLATION AND DRAINAGE.
- INSTALL IRRIGATION MAIN LINES, WIRING, AND STUB UP VALVE LOCATIONS TO WITHIN EIGHT INCHES OF EXISTING SURFACE GRADE.
- SPRAY EXISTING MEDIANS WITH CONTACT HERBICIDE FOR 100% KILL OF EXISTING GRASS AS APPROVED BY LANDSCAPE ARCHITECT AND MAINTAIN MEDIANS WEED-FREE DURING INSTALLATION UNTIL FINAL ACCEPTANCE.
- CUT EXISTING SOIL BEHIND BACK OF CURBING IF REQUIRED TO PROPOSED 2" DEPTH AND SPREAD CUT INWARD TOWARD THE CENTER OF THE MEDIAN AND ROUGH GRADE PER PROFILE.
- ROTOR TILL MEDIAN TO AN 8-10" DEPTH TO WITHIN 6 INCHES OF THE BACK OF CURBING. ROTOR TILLING MEANS 6 TOTAL PASSES OF THE AREA TILLED WITH REVERSE ROTOR TYPE TILLER OR DISC PLOW.
- FINE GRADE MEDIANS TO PROPOSED PROFILES AND REMOVE ALL DEBRIS LARGER THAN 1 INCH IN DIAMETER FROM WITHIN THE TOP 4 INCHES OF THE FINISHED GRADE.
- ADD FINISHED SOIL LAYER MATERIAL AS REQUIRED TO PROVIDE FOR PROPOSED GRADES/PROFILES. MAKE ONE MORE PASS WITH ROTOR TILLER/DISC TO MIX ADDITIONAL TOPSOIL INTO EXISTING SOIL.
- TOPSOIL SHALL NOT BE EXTREMELY ACIDIC OR ALKALINE, NOR CONTAIN TOXIC SUBSTANCES WHICH MAY BE HARMFUL TO PLANT GROWTH. THE pH SHALL BE IN THE RANGE OF 6.5 TO 7.0. IF NECESSARY, THE CONTRACTOR TOPSOIL pH SHALL APPLY THE APPROPRIATE SOIL AMENDMENTS ADJUSTING SOIL pH TO ASSURE A pH RANGE OF 6.5 TO 7.0.
- THE CONTRACTOR SHALL BE RESPONSIBLE FOR HAVING TOPSOIL TESTED. REPRESENTATIVE SAMPLES ARE TO BE TESTED FOR ACIDITY, FERTILITY, AND GENERAL COMPOSITION BY A RECOGNIZED COMMERCIAL OR GOVERNMENT AGENCY. THE CONTRACTOR SHALL FURNISH ONE (1) COPY OF THE SOIL ANALYSIS AND RECOMMENDED AMENDMENTS (TO MEET THE DESIRED pH, NUTRITIONAL AND ORGANIC LEVELS DETERMINED TO BE ADEQUATE FOR THE AREA) PREPARED BY THE TESTING AGENCY, TO THE LANDSCAPE ARCHITECT PRIOR TO APPLICATION OF ANY AMENDMENTS OR FERTILIZER.
- TOPSOIL SHALL BE NATURAL, FERTILE, AGRICULTURAL SOIL CAPABLE OF SUSTAINING VIGOROUS PLANT GROWTH. IT SHALL BE OF UNIFORM COMPOSITION THROUGHOUT, WITHOUT ADMIXTURE OF SUBSOIL, CLAY, STONES, LUMPS, LIVE PLANTS AND THEIR ROOTS, STICKS, AND OTHER EXTRANEIOUS MATTER. REMOVE ALL ROCKS AND OTHER OBJECTS OVER 1 INCH IN DIAMETER.

PLANTING

- ALL PLANTS MUST BE HEALTHY, VIGOROUS MATERIAL, FREE OF PESTS AND DISEASES. ALL PLANT MATERIAL SHALL BE IN FULL AND STRICT ACCORDANCE TO FLORIDA NO. 1 GRADE, ACCORDING TO THE "GRADES AND STANDARD FOR NURSERY PLANTS", 1998, 2ND EDITION, PUBLISHED BY FLORIDA DEPARTMENT OF AGRICULTURE AND CONSUMER SERVICES. PLANT MATERIALS IN SOME INSTANCES EXCEED NO. 1 GRADE IN ORDER TO MEET THE MINIMUM REQUIREMENTS OF THIS PROJECT.
- ALL PLANTS NOT LISTED IN GRADES AND STANDARDS FOR NURSERY PLANTS, 1998, 2ND EDITION, SHALL CONFORM TO A FLORIDA NO. 1 AS TO; 1. HEALTH AND VITALITY; 2. CONDITION OF FOLIAGE; 3. ROOT SYSTEM; 4. FREEDOM FROM PEST OR MECHANICAL DAMAGE; 5. HEAVILY BRANCHED AND DENSELY FOLIATED ACCORDING TO THE ACCEPTED NORMAL SHAPE OF THE SPECIES.
- CONTRACTOR SHALL BE RESPONSIBLE FOR PLANTS MEETING SPECIFICATION AS NOTED PRIOR TO INSTALLATION. CONTRACTOR SHALL IMMEDIATELY REMOVE ALL PLANT MATERIAL THAT DOES NOT CONFORM TO SPECIFICATIONS.
- ALL ROOTBALLS SHALL CONFORM TO THE SIZE STANDARDS SET FORTH IN "AMERICAN STANDARDS FOR NURSERY STOCK".
- ALL PLANT MATERIAL SHALL BE PROTECTED DURING TRANSPORT AND DELIVERY TO JOB SITE WITH SHADE CLOTH OR OTHER ACCEPTABLE MEANS OF WINDBURN PREVENTION.
- CONTRACTOR SHALL FIELD VERIFY ALL INFORMATION PRIOR TO INITIATING PLANTING INSTALLATION. ALL EXISTING PLANTING SHALL REMAIN INTACT AND UNDISTURBED UNLESS OTHERWISE NOTED ON THE PLANS.
- ALL TREES MUST BE STRAIGHT TRUNKED, FULL HEADED, AND MEET ALL REQUIREMENTS SPECIFIED.
- ANY SUBSTITUTIONS IN SIZE AND/OR PLANT MATERIAL MUST BE APPROVED BY THE LANDSCAPE ARCHITECT AND OWNER. ALL PLANTS WILL BE SUBJECT TO APPROVAL BY LANDSCAPE ARCHITECT BEFORE PLANTING CAN BEGIN.
- THE CONTRACTOR SHALL FIELD STAKE THE LOCATION OF ALL PLANT MATERIAL AND BEDLINES PRIOR TO INITIATING INSTALLATION FOR THE REVIEW AND APPROVAL OF THE LANDSCAPE ARCHITECT.
- TYPICALLY, SHRUB AND GROUNDCOVER PLANTINGS ARE SHOWN AS MASS PLANTING BEDS. PLANTS SHALL BE PLACED ON A TRIANGULAR SPACING CONFIGURATION (STAGGERED SPACING) AS SHOWN IN THE PLANTING DETAILS. PLANT CENTER TO CENTER DIMENSIONS (O.C.) ARE LISTED ON THE PLANT LIST.
- INSTALLATION - ALL PLANT MATERIAL SHALL BE INSTALLED IN A SOUND, WORKMANLIKE MANNER AND ACCORDING TO ACCEPTED GOOD PLANTING PROCEDURES WITH THE QUALITY OF PLANT MATERIALS AS HEREINAFTER DESCRIBED. ALL ELEMENTS OF LANDSCAPING SHALL BE INSTALLED SO AS TO MEET ALL APPLICABLE ORDINANCES AND CODE REQUIREMENTS.
- CONTRACTOR SHALL ASSURE DRAINAGE AND PERCOLATION OF ALL PLANTING PITS PRIOR TO INSTALLATION OF PLANT MATERIAL. CONTRACTOR SHALL FILL ALL TREE PITS WITH WATER BEFORE PLANTING TO ASSURE THAT PROPER DRAINAGE AND PERCOLATION IS AVAILABLE. CORRECT IF REQUIRED TO ASSURE PERCOLATION. CONTRACTOR IS RESPONSIBLE FOR REPLACEMENT OF ALL PLANTS LOST DUE TO INADEQUATE DRAINAGE CONDITIONS.
- TREES GROWN IN GROW BAGS OR GROW BAG TYPE MATERIAL MUST HAVE THE GROW BAG REMOVED ENTIRELY PRIOR TO PLANTING .
- BALLED AND BURLAPPED MATERIAL SHALL HAVE THE TOP ONE HALF (1/2) OF THE BURLAP AROUND THE BASE OF THE TRUNK CUT AND PULLED BACK. DO NOT REMOVE BURLAP. WIRE CAGES, STRAPS, ETC. MUST BE CUT AND REMOVED PRIOR TO INSTALLATION. ALL PLASTIC WRAPPING SHALL BE REMOVED PRIOR TO INSTALLATION.
- CONTRACTOR TO REPLACE REJECTED PLANT MATERIAL WITHIN ONE (1) WEEK OF NOTICE FROM THE OWNER OR LANDSCAPE ARCHITECT.
- CONTRACTOR SHALL REFER TO THE LANDSCAPE PLANTING DETAILS, PLANTS LIST, GENERAL NOTES AND THE PLANTING SPECIFICATIONS FOR COMPLETE LANDSCAPE PLANTING INSTRUCTIONS.
- FERTILIZATION
PALMS 8-2-12 PLUS MINOR ELEMENTS - SLOW RELEASE 1/2 LB FERTILIZER PER 1/2 INCH CALIPER. SUPPLEMENT WITH SOPO-MAG MICRONUTRIENTS. APPLY GRANULAR SULPHUR AT THE RECOMMENDED APPLICATION RATES.
SHRUBS AND GROUNDCOVERS 8-10-10 PLUS MINOR ELEMENTS - SLOW RELEASE 1/2 LB FERTILIZER PER 100 FT2
TREES 8-6-6 PLUS MINOR ELEMENTS - SLOW RELEASE 1/2 LB FERTILIZER PER 1/2 INCH CALIPER
TURF 16-4-8 PLUS MINOR ELEMENTS - SLOW RELEASE 1 LB FERTILIZER PER 1000 FT2
 * THE COST FOR LANDSCAPE FERTILIZER AS DESCRIBED ABOVE SHALL BE INCLUDED IN THE PER PLANT PRICE.
- GUYING / STAKING PRACTICES SHALL NOT PERMIT NAILS, SCREWS, WIRES ETC., TO PENETRATE OUTER SURFACE OF TREE OR PALM. TREES OR PALMS REJECTED DUE TO THIS PRACTICE SHALL BE REPLACED.
- CONTRACTOR SHALL MULCH ALL PLANT MATERIAL THROUGHOUT AND COMPLETELY TO A THREE (3) INCH WATERED-IN DEPTH WITH CLEAN, WEED FREE MULCH AS SPECIFIED.

SOIL AMENDMENTS / BACKFILL MIX

- CONTRACTOR TO APPLY "RONSTAR" OR APPROVED PRE-EMERGENT HERBICIDE IN ACCORDANCE WITH MANUFACTURER'S RATE AND SPECIFICATIONS.
- PLANTING SOIL MIX FOR TREES, SHRUBS, AND GROUNDCOVERS SHALL CONSIST OF A THOROUGHLY BLENDED MIXTURE OF:
 50% TOPSOIL / EXISTING SOIL IF ACCEPTABLE
 50% COMPOSTED SOIL AMENDMENTS, WHICH SHALL CONSIST OF PEAT, COMPOSTED PINE BARK AND HARDWOOD FINES
 PROVIDE THE FOLLOWING AMOUNT OF COMPOSTED SOIL AMENDMENTS PER PLANT:
 -13 CF / LARGE TREE (>16")
 -9 CF / SMALL TREE OR PALM (10-16")
 -6 CF / MEDIUM TREE OR PALM (<10")
 -1 CF / 3 GAL SHRUB OR LARGER
 -5 CF / 1 GAL GROUNDCOVER
 -6" DEPTH ALL ANNUAL BEDS
- COMPOST MIX SHALL BE FREE OF DELETERIOUS MATERIALS THAT WOULD BE HARMFUL TO PLANT GROWTH, SHALL BE FREE OF NEMATODES, SHALL BE OF UNIFORM QUALITY AND SHALL HAVE A PH VALUE BETWEEN 5.5 AND 6.5 (AS DETERMINED IN ACCORDANCE WITH ASTM E70). FLORIDA PEAT SHALL BE STERILIZED TO MAKE FREE OF ALL VIABLE NUT GRASS AND OTHER UNDESIRABLE WEEDS.

PROJECT COMPLETION AND WARRANTY

- COMPLETION OF THE WORK SHALL MEAN THE FULL AND EXACT COMPLIANCE AND CONFORMITY WITH THE PROVISIONS EXPRESSED OR IMPLIED IN THE DRAWINGS AND SPECIFICATIONS, AND ASSOCIATED CHANGE ORDERS.
- SUBSTANTIAL COMPLETION: UPON NOTIFICATION BY THE CONTRACTOR THAT THE INSTALLATION IS COMPLETE, THE LANDSCAPE ARCHITECT WILL PERFORM A SUBSTANTIAL COMPLETION SITE OBSERVATION TO DETERMINE IF THE CONTRACTOR HAS COMPLETED THE WORK IN ACCORDANCE WITH THE PLANS AND SPECIFICATIONS. IF FINAL ACCEPTANCE IS NOT GIVEN, THE LANDSCAPE ARCHITECT WILL PREPARE A "PUNCH LIST." THE NOTIFICATION BY THE CONTRACTOR MUST BE MADE AT LEAST THREE (3) WORKING DAYS BEFORE THE ANTICIPATED SUBSTANTIAL COMPLETION SITE OBSERVATION.
- FINAL ACCEPTANCE: UPON NOTIFICATION BY THE CONTRACTOR THAT ALL DEFECTS HAVE BEEN CORRECTED, THE LANDSCAPE ARCHITECT WILL PERFORM A FINAL SITE OBSERVATION. FINAL ACCEPTANCE WILL BE GIVEN UPON SATISFACTORY COMPLETION OF ALL WORK, INCLUDING "PUNCH LIST" ITEMS. THE NOTIFICATION BY CONTRACTOR MUST BE MADE AT LEAST THREE (3) WORKING DAYS BEFORE THE ANTICIPATED FINAL SITE OBSERVATION.
- CONTRACTOR TO GUARANTEE PLANT MATERIAL FOR A 12 MONTH PERIOD. THE CONTRACTOR SHALL VISIT THE SITE ONCE A MONTH TO REVIEW THE STATUS OF MAINTENANCE BY THE OWNER AND ADVISE IN WRITING ANY ACTIVITIES OR DISCREPANCIES THAT ARE POTENTIALLY DETRIMENTAL TO THE LANDSCAPE INSTALLATION OR MAY VOID WARRANTY.
- LANDSCAPE WHICH WAS INSTALLED IN ACCORDANCE WITH THE DRAWINGS AND SPECIFICATIONS AND IS DAMAGED OR DESTROYED THROUGH VANDALISM, THEFT, OR TRAFFIC, SHALL BE REPLACED BY THE CONTRACTOR AT THE CONTRACTOR'S EXPENSE THROUGH THE CONSTRUCTION PERIOD AND UNTIL FINAL ACCEPTANCE.
- AFTER FINAL ACCEPTANCE BY THE LANDSCAPE ARCHITECT, THE OWNER SHALL BE RESPONSIBLE FOR THE MAINTENANCE OF THE LANDSCAPING. IT SHALL BE UNDERSTOOD THAT IN ACCORDANCE WITH THE TERMS OF THE WARRANTY THAT THE CONTRACTOR MUST PROMPTLY INFORM THE OWNER IF PROPER MAINTENANCE IS NOT BEING GIVEN TO THE INSTALLATION. INSPECTIONS BY CONTRACTOR OF THE JOB SHALL BE MADE DURING THE WARRANTY PERIOD TO DETERMINE IF PROPER MAINTENANCE IS BEING GIVEN.
- AT THE END OF THE ONE YEAR WARRANTY PERIOD, INSPECTIONS SHALL BE MADE JOINTLY BY THE OWNER, LANDSCAPE ARCHITECT AND CONTRACTOR. ALL PLANTS NOT IN A HEALTHY GROWING CONDITION SHALL BE REMOVED AND REPLACED WITH PLANTS OF A LIKE KIND AND SIZE, EXCEPT FOR DEFECTS RESULTING FROM NEGLIGENCE BY OWNER, ABUSE OR DAMAGE BY OTHERS, OR UNUSUAL PHENOMENA OR INCIDENTS WHICH ARE BEYOND CONTRACTOR'S CONTROL.
- ALL REPLACEMENT STOCK SHALL BE SUBJECT TO THE SAME WARRANTY REQUIREMENTS AS THE ORIGINAL STOCK, PERIOD TO BEGIN UPON ACCEPTANCE OF THE REPLACEMENT BY THE LANDSCAPE ARCHITECT. ANY DAMAGE DUE TO REPLACEMENT OPERATIONS SHALL BE REPAIRED BY THE CONTRACTOR.



IN COORDINATION WITH:
Stantec
 1821 VICTORIA AVENUE
 FORT MYERS, FL 33901

PREPARED FOR:
 LEE COUNTY
 DEPARTMENT OF
 TRANSPORTATION

LITTLETON ROAD
 CONTRACT NO.: CN190114
 LEE COUNTY, FL

SCALE:	
DATE:	DECEMBER 2021
PROJECT #:	
REV	DATE DESCRIPTION

LANDSCAPE SPECIFICATIONS

SHEET #
LA-11

DAYNA L. FENDORICK, RLA #0001224

C:\Users\tonya\OneDrive\Documents\CLEAN LINES\Urban Green Studio\LittletonExtension\Construction Docs\Littleton-Extension.dwg, 4/28/2023 9:26:37 AM

TABULATION OF QUANTITIES / PLANT SCHEDULE

100% PLAN SUBMITTAL

December 7, 2021

PAY ITEM NO.	SYM	BOTANICAL NAME	COMMON NAME	SIZE/SPACING	MAX. MAINT. SIZE	UNIT	QUANTITIES BY SHEET NUMBER						TOTAL QTY
							LA-1	LA-2	LA-3	LA-4	LA-5	LA-6	
TREES & PALMS													
	CA	Coccothrinax argentata	Florida Silver Palm	25 gal, 4-5' ht	8-10' ht	EA		3	3			6	
	IA	Ilex attenuata "Eagleston"	Eagleston Holly	30 gal, 10' ht, 4' spd	30' ht	EA		7		2	3	12	
	PE	Ptychosperma elegans	Alexander Palm	12-14' OA ht	25-30' ht	EA	5		5	3	3	16	
LOW SHRUB / GROUND COVERS													
	AG	Arachis glabrata	Perennial Peanut	4" pots, 12" oc	8 -10" ht	EA					460	460	
	CN	Clusia "Nana"	Dwarf Clusia (small-leaf)	3 gal, 15" x 15", 30" oc	24" ht	EA	44		44	22	22	132	
	LE	Liriope muscari "Emerald Goddess"	Emerald Goddess Liriope	1 gal, 12" x 12", 24" oc	18" ht	EA		81	81			162	
MISCELLANEOUS													
	SOD	Paspalum notatum	Bahia Sod	Solid Sod, free of weeds & pests		SF	1638	2565	3759	4559	2603	15124	
	N/A	Coco Brown Shredded Mulch	2900 SF including beds & tree rings	2 CF bags, 3" depth		BAGS	70	56	103	40	94	363	
	N/A	Soil Amendments	6" depth all planting areas + tree pits			CY						60	

NOTE: All staking and fertilizers as called out in the details and specifications are to be included in the unit planting price.



IN COORDINATION WITH:
 Stantec
 1821 VICTORIA AVENUE
 FORT MYERS, FL 33901

PREPARED FOR:
 LEE COUNTY
 DEPARTMENT OF
 TRANSPORTATION

LITTLETON ROAD
 CONTRACT NO.: CN190114
 LEE COUNTY, FL

SCALE:	
DATE:	DECEMBER 2021
PROJECT #:	
REV	DATE DESCRIPTION

PLANT SCHEDULE

DAYNA L. FENDORICK, RLA #0001224

SHEET #
LA-12

C:\Users\tonya\OneDrive\Documents\CLEAN LINES\Urban Green Studio\LittletonExtension\Construction Docs\Littleton-Extension.dwg, 4/28/2023 9:53:53 AM

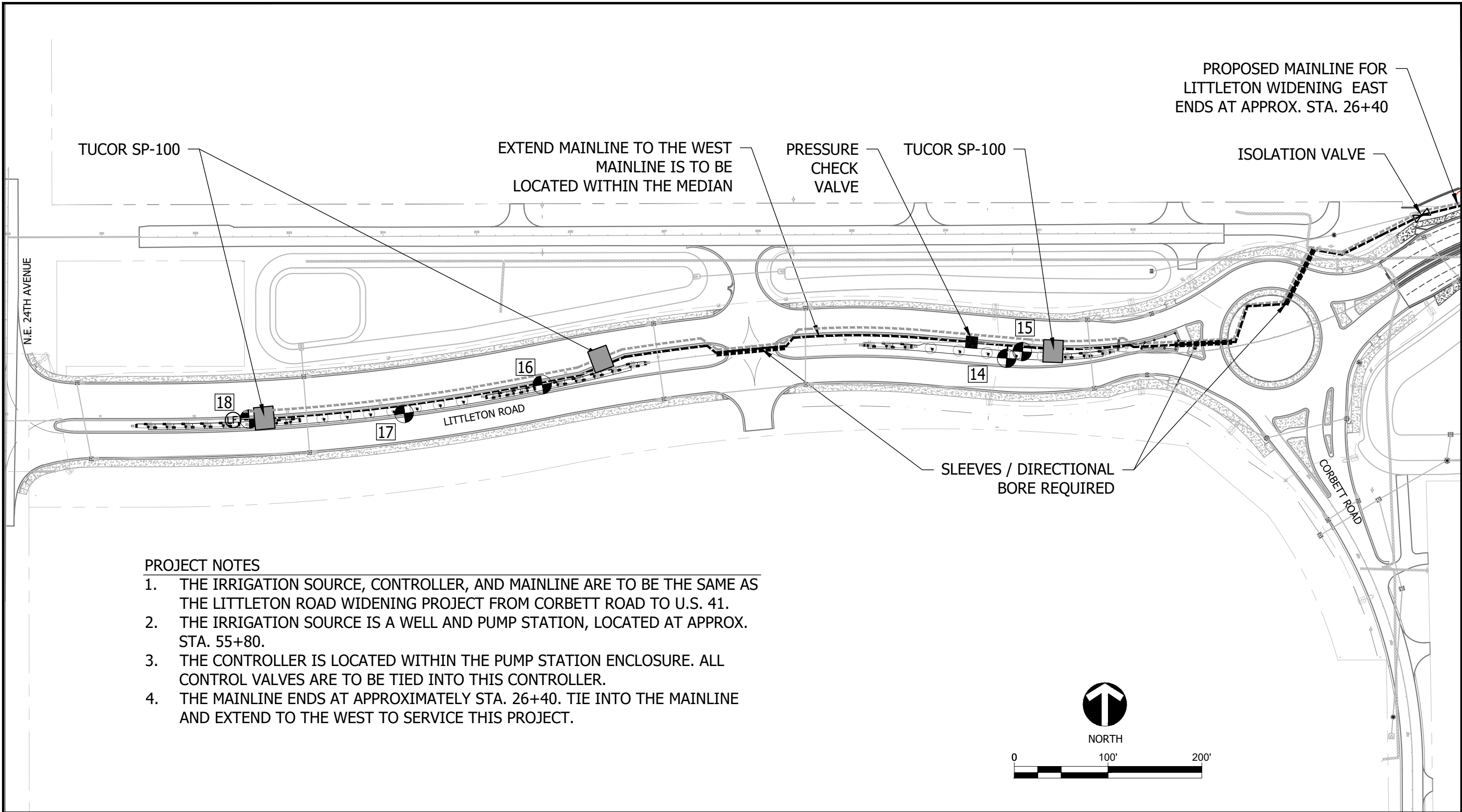

PROPOSED MAINLINE FOR
LITTLETON WIDENING EAST
ENDS AT APPROX. STA. 26+40

TUCOR SP-100

EXTEND MAINLINE TO THE WEST
MAINLINE IS TO BE
LOCATED WITHIN THE MEDIAN

PRESSURE
CHECK
VALVE

TUCOR SP-100

ISOLATION VALVE

N.E. 24TH AVENUE

18

17

16

LITTLETON ROAD

14

15

SLEEVES / DIRECTIONAL
BORE REQUIRED

CORBETT ROAD

PROJECT NOTES

1. THE IRRIGATION SOURCE, CONTROLLER, AND MAINLINE ARE TO BE THE SAME AS THE LITTLETON ROAD WIDENING PROJECT FROM CORBETT ROAD TO U.S. 41.
2. THE IRRIGATION SOURCE IS A WELL AND PUMP STATION, LOCATED AT APPROX. STA. 55+80.
3. THE CONTROLLER IS LOCATED WITHIN THE PUMP STATION ENCLOSURE. ALL CONTROL VALVES ARE TO BE TIED INTO THIS CONTROLLER.
4. THE MAINLINE ENDS AT APPROXIMATELY STA. 26+40. TIE INTO THE MAINLINE AND EXTEND TO THE WEST TO SERVICE THIS PROJECT.



NORTH

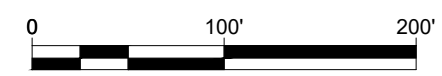

IN COORDINATION WITH:
Stantec
1821 VICTORIA AVENUE
FORT MYERS, FL 33901

PREPARED FOR:
LEE COUNTY
DEPARTMENT OF
TRANSPORTATION

LITTLETON ROAD
CONTRACT NO.: CN190114
LEE COUNTY, FL

REV	DATE	DESCRIPTION

SCALE: 1" = 100'
DATE: DECEMBER 2021
PROJECT #:

IRRIGATION
MASTER PLAN

DAYNA L. FENDORICK, RLA #0001224

SHEET #
IR-M

C:\Users\tonya\OneDrive\Documents\CLEAN LINES\Urban Green Studio\LittletonExtension\Construction Docs\Littleton-Extension.dwg, 4/28/2023 9:54:16 AM

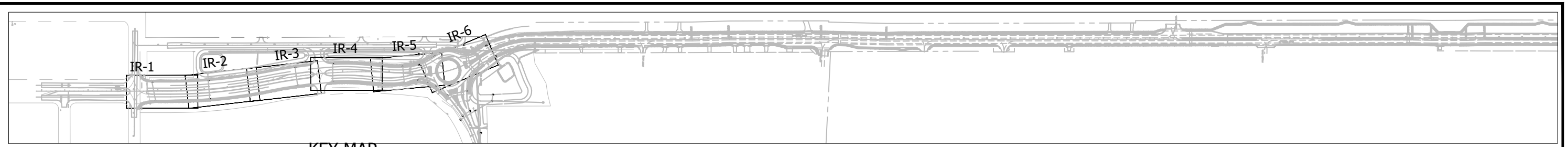

KEY MAP

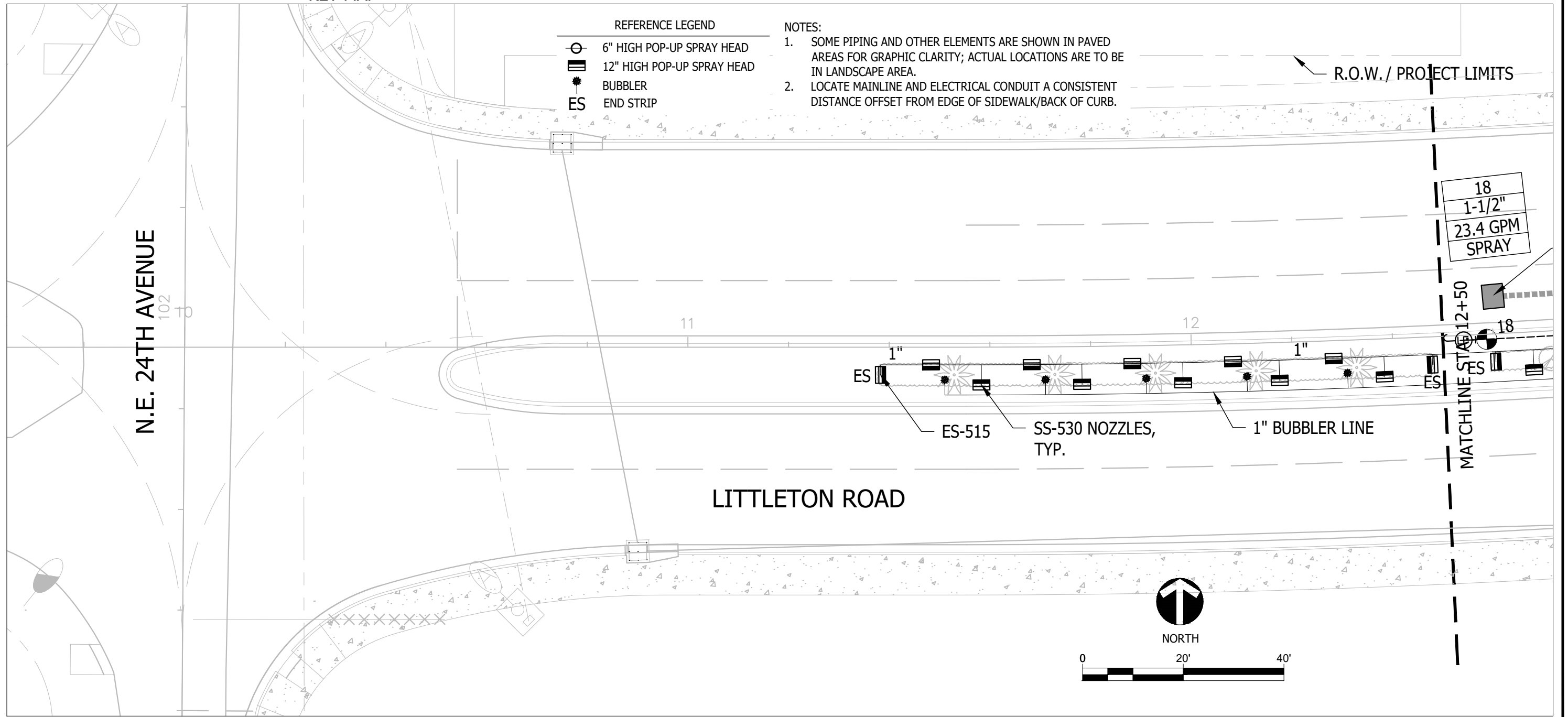

IN COORDINATION WITH:
Stantec
 1821 VICTORIA AVENUE
 FORT MYERS, FL 33901

PREPARED FOR:
 LEE COUNTY
 DEPARTMENT OF
 TRANSPORTATION

LITTLETON ROAD
 CONTRACT NO.: CN190114
 LEE COUNTY, FL

REV	DATE	DESCRIPTION

SCALE: 1" = 20'
 DATE: DECEMBER 2021
 PROJECT #:

IRRIGATION PLAN

DAYNA L. FENDORICK, RLA #0001224

SHEET #
IR-1

C:\Users\tonya\OneDrive\Documents\CLEAN LINES\Urban Green Studio\LittletonExtension\Construction Docs\Littleton-Extension.dwg, 4/28/2023 9:54:10 AM

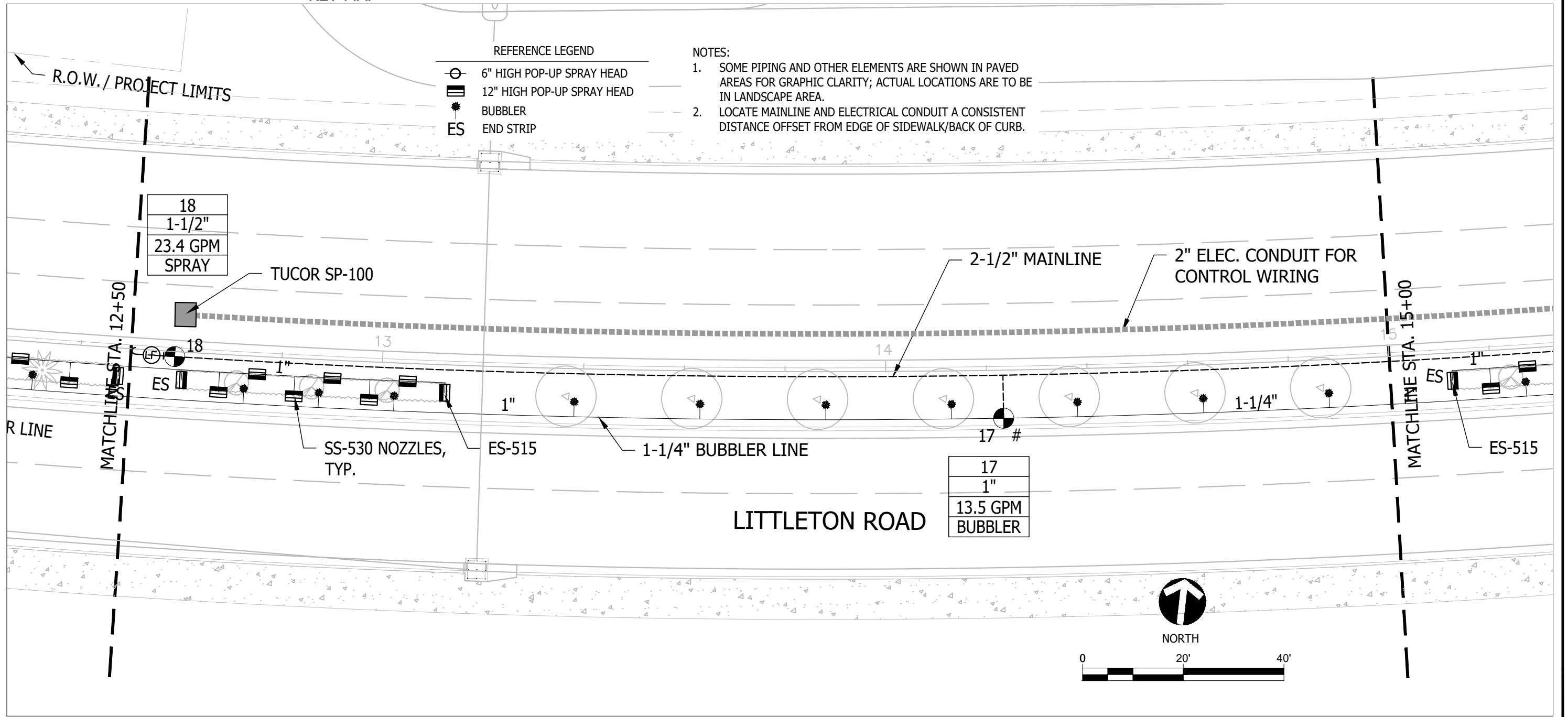
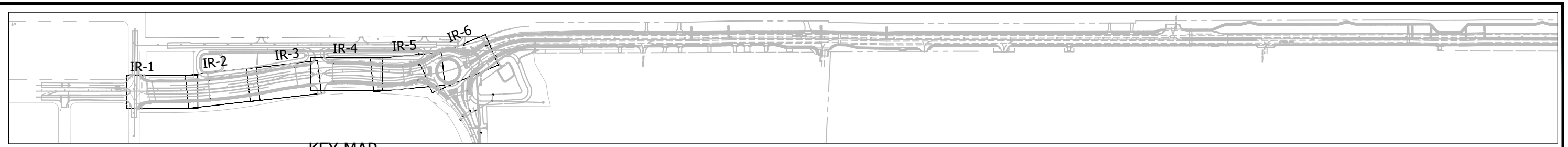

IN COORDINATION WITH:
Stantec
1821 VICTORIA AVENUE
FORT MYERS, FL 33901

PREPARED FOR:
LEE COUNTY
DEPARTMENT OF
TRANSPORTATION

LITTLETON ROAD
CONTRACT NO.: CN190114
LEE COUNTY, FL

REV	DATE	DESCRIPTION

SCALE: 1" = 20'
DATE: DECEMBER 2021
PROJECT #:

IRRIGATION PLAN

DAYNA L. FENDORICK, RLA #0001224

SHEET #
IR-2

C:\Users\tonya\OneDrive\Documents\CLEAN LINES\Urban Green Studio\LittletonExtension\Construction Docs\Littleton-Extension.dwg, 4/28/2023 9:54:42 AM

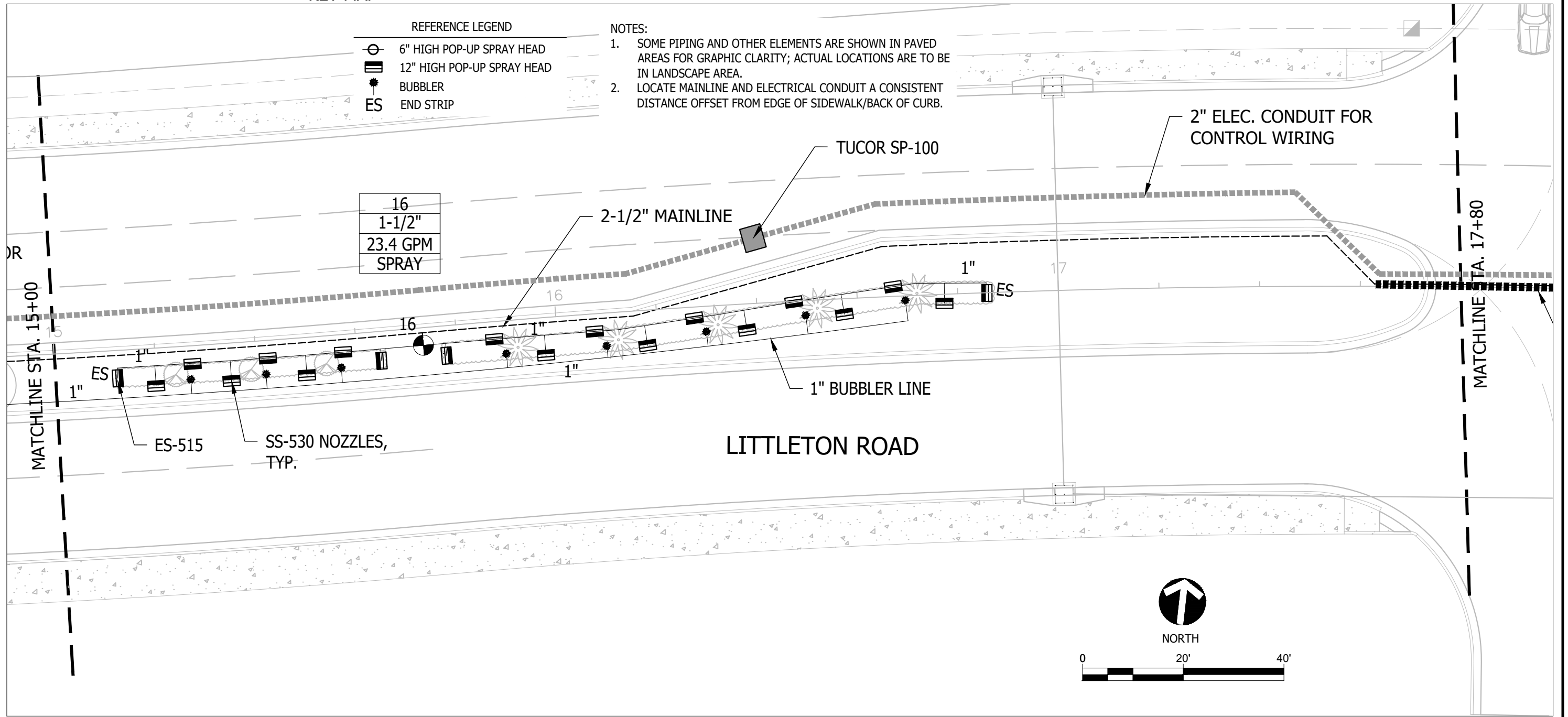
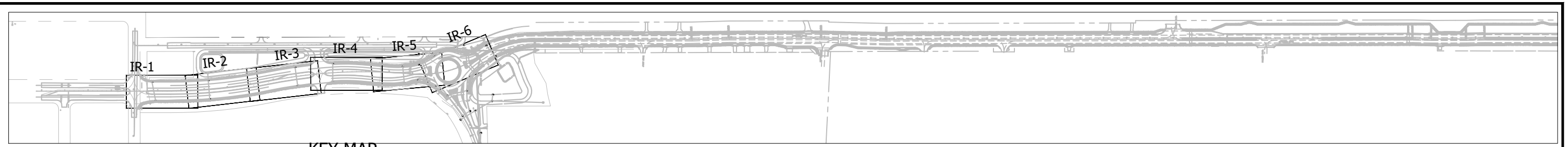

IN COORDINATION WITH:
Stantec
1821 VICTORIA AVENUE
FORT MYERS, FL 33901

PREPARED FOR:
LEE COUNTY
DEPARTMENT OF
TRANSPORTATION

LITTLETON ROAD
CONTRACT NO.: CN190114
LEE COUNTY, FL

REV	DATE	DESCRIPTION

SCALE: 1" = 20'
DATE: DECEMBER 2021
PROJECT #:

IRRIGATION PLAN

SHEET #
IR-3

DAYNA L. FENDORICK, RLA #0001224

C:\Users\tonya\OneDrive\Documents\CLEAN LINES\Urban Green Studio\LittletonExtension\Construction Docs\Littleton-Extension.dwg, 4/28/2023 9:54:04 AM

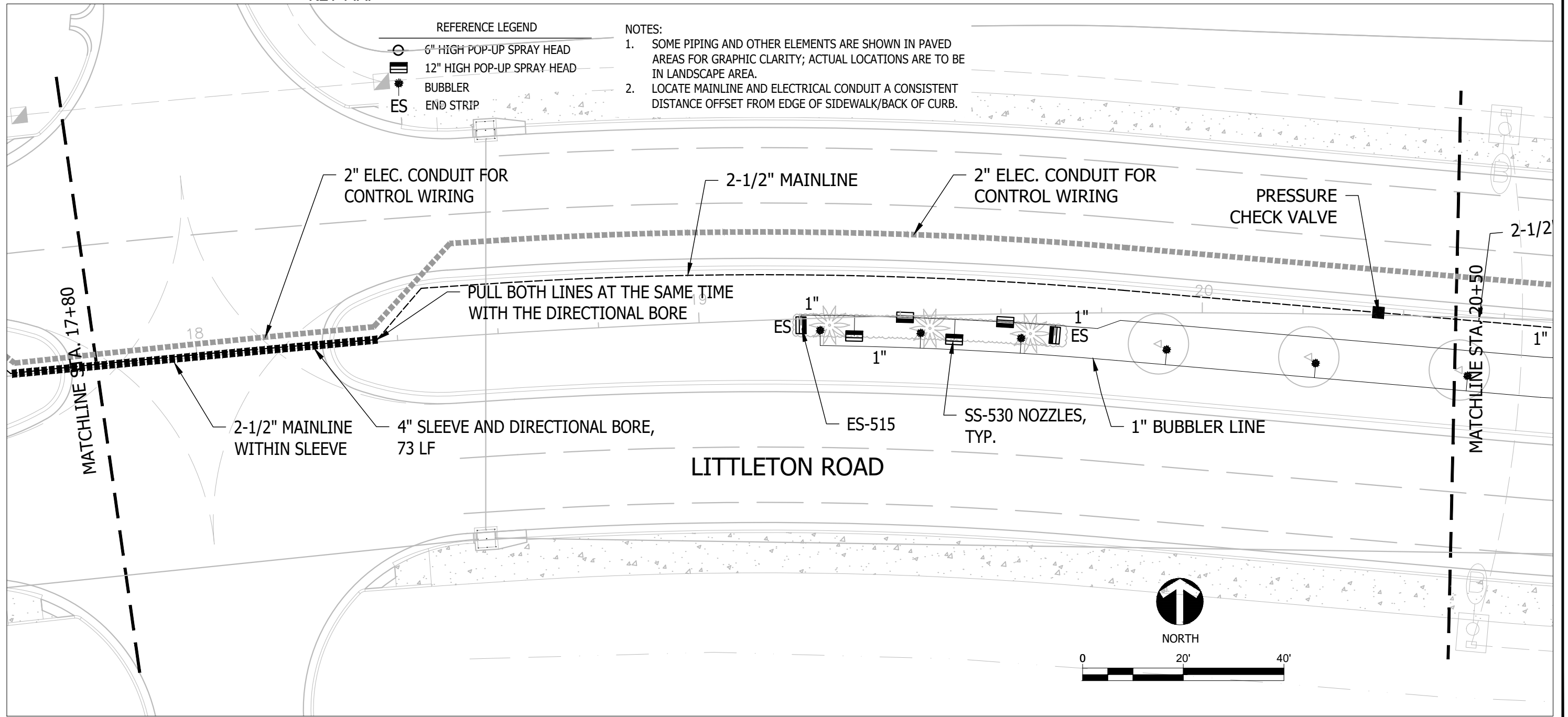
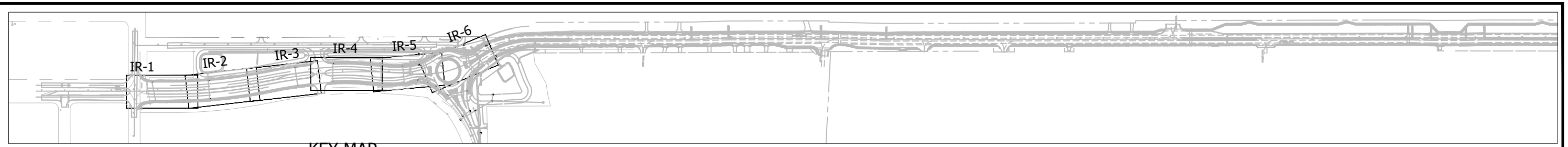

IN COORDINATION WITH:
Stantec
 1821 VICTORIA AVENUE
 FORT MYERS, FL 33901

PREPARED FOR:
 LEE COUNTY
 DEPARTMENT OF
 TRANSPORTATION

LITTLETON ROAD
 CONTRACT NO.: CN190114
 LEE COUNTY, FL

REV	DATE	DESCRIPTION

SCALE: 1" = 20'
 DATE: DECEMBER 2021
 PROJECT #:

IRRIGATION PLAN

DAYNA L. FENDRICK, RLA #0001224

SHEET #
IR-4

C:\Users\tonya\OneDrive\Documents\CLEAN LINES\Urban Green Studio\LittletonExtension\Construction Docs\Littleton-Extension.dwg, 4/28/2023 9:54:53 AM

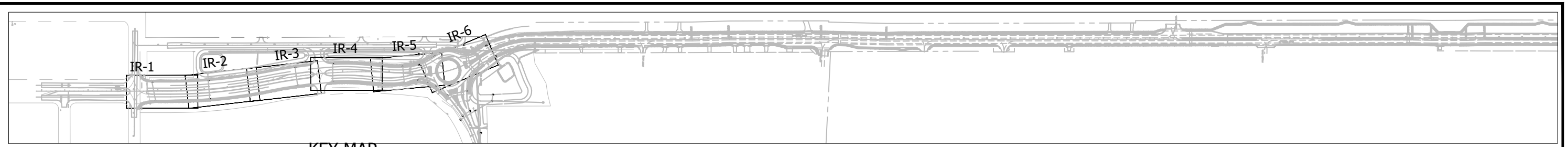

KEY MAP

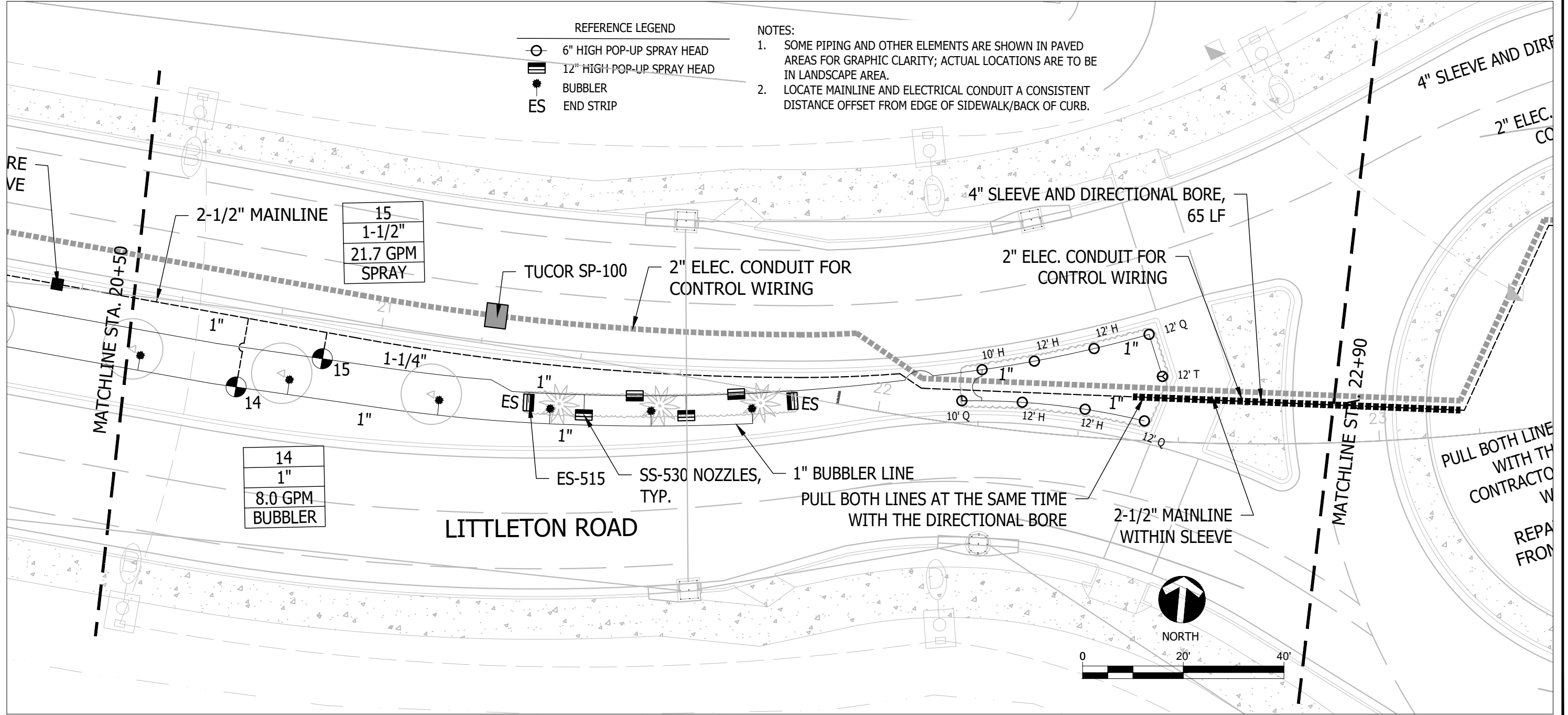

REFERENCE LEGEND

	6" HIGH POP-UP SPRAY HEAD
	12" HIGH POP-UP SPRAY HEAD
	BUBBLER
ES	END STRIP

- NOTES:
- SOME PIPING AND OTHER ELEMENTS ARE SHOWN IN PAVED AREAS FOR GRAPHIC CLARITY; ACTUAL LOCATIONS ARE TO BE IN LANDSCAPE AREA.
 - LOCATE MAINLINE AND ELECTRICAL CONDUIT A CONSISTENT DISTANCE OFFSET FROM EDGE OF SIDEWALK/BACK OF CURB.

15
1-1/2"
21.7 GPM
SPRAY

14
1"
8.0 GPM
BUBBLER

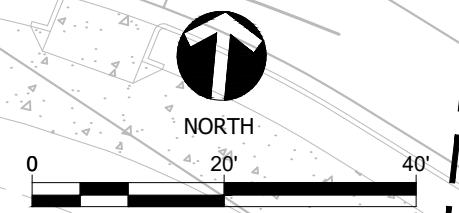

 <small>P.O. BOX 111841, NAPLES, FLORIDA 34108 PHONE (239) 263-4629 FAX (239) 594-7091</small>	IN COORDINATION WITH: <small>1821 VICTORIA AVENUE FORT MYERS, FL 33901</small>	PREPARED FOR: LEE COUNTY DEPARTMENT OF TRANSPORTATION	LITTLETON ROAD CONTRACT NO.: CN190114 LEE COUNTY, FL	<table border="1" style="width:100%; border-collapse: collapse;"> <tr> <td>SCALE:</td> <td>1" = 20'</td> </tr> <tr> <td>DATE:</td> <td>DECEMBER 2021</td> </tr> <tr> <td>PROJECT #:</td> <td></td> </tr> </table>	SCALE:	1" = 20'	DATE:	DECEMBER 2021	PROJECT #:		<h2 style="margin:0;">IRRIGATION PLAN</h2>	SHEET # <h1 style="margin:0;">IR-5</h1>
SCALE:	1" = 20'											
DATE:	DECEMBER 2021											
PROJECT #:												

DAYNA L. FENDORICK, RLA #0001224

C:\Users\tonya\OneDrive\Documents\CLEAN LINES\Urban Green Studio\LittletonExtension\Construction Docs\Littleton-Extension.dwg, 4/28/2023 9:54:36 AM

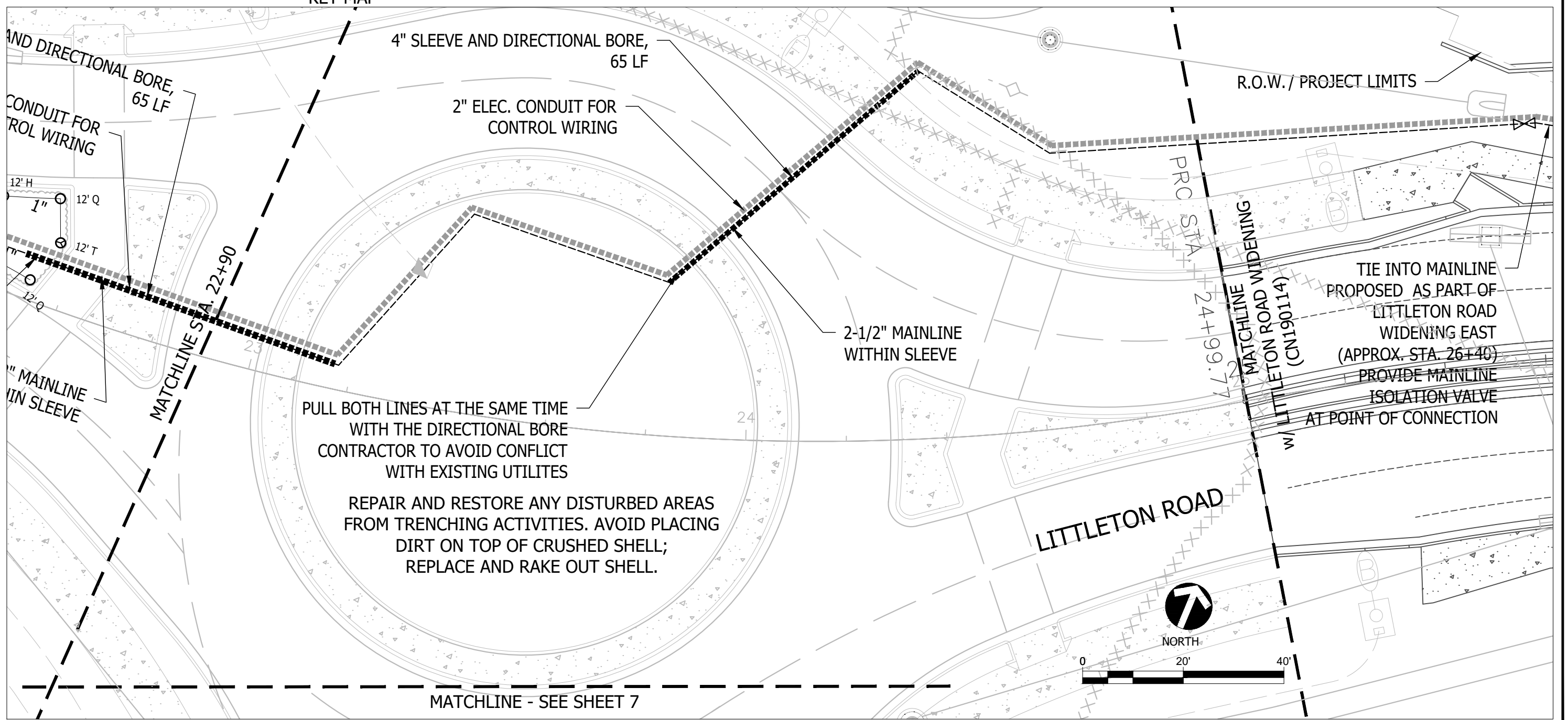
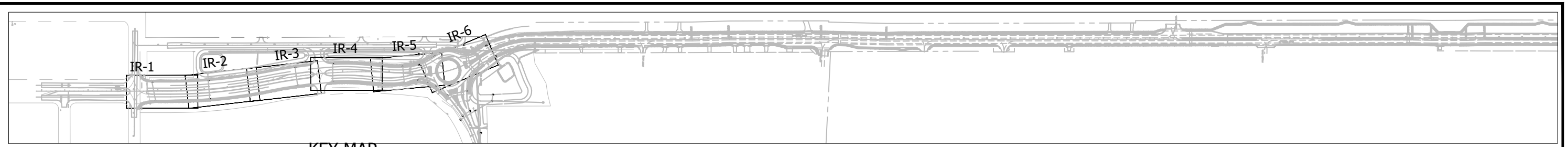

IN COORDINATION WITH:
Stantec
 1821 VICTORIA AVENUE
 FORT MYERS, FL 33901

PREPARED FOR:
 LEE COUNTY
 DEPARTMENT OF
 TRANSPORTATION

LITTLETON ROAD
 CONTRACT NO.: CN190114
 LEE COUNTY, FL

SCALE:	1" = 20'	
DATE:	DECEMBER 2021	
PROJECT #:		
REV	DATE	DESCRIPTION

IRRIGATION PLAN

SHEET #
IR-6

DAYNA L. FENDORICK, RLA #0001224

C:\Users\tonya\OneDrive\Documents\CLEAN LINES\Urban Green Studio\LittletonExtension\Construction Docs\Littleton-Extension.dwg, 4/28/2023 9:53:59 AM

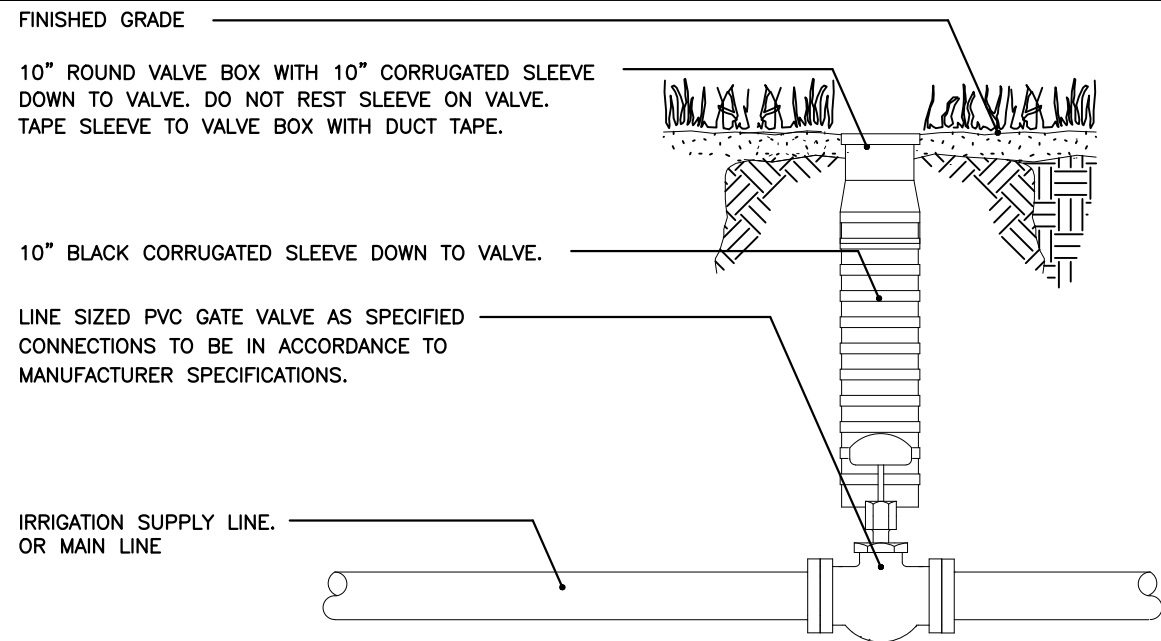

MAIN LINE ISOLATION MANUAL GATE VALVE INSTALLATION DETAIL
N.T.S.

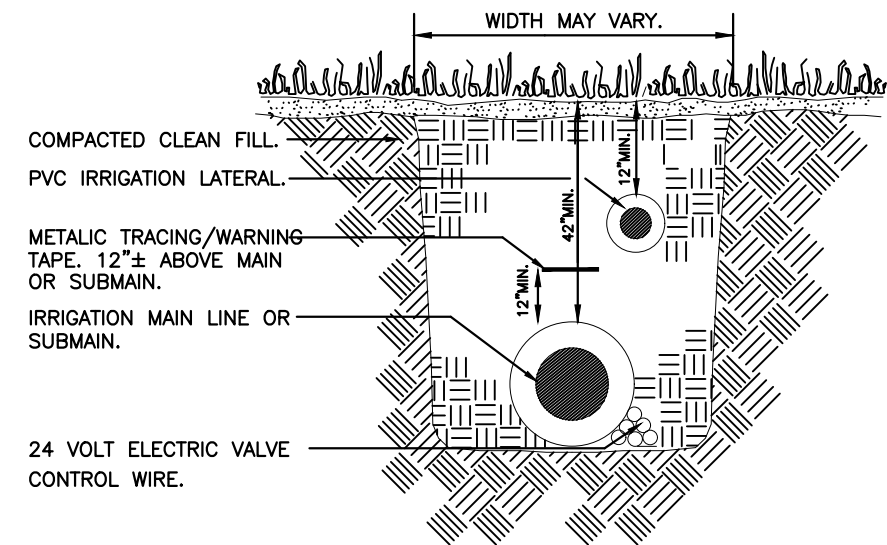

ALL TRENCHING DEPTHS SHOWN ARE MINIMUM. IN THE EVENT THAT MINIMUM TRENCHING DEPTHS ARE NOT MET, THE TRENCHES SHALL BE RE-EXCAVATED.

DEPTH MEASUREMENTS ARE TO BE DONE FROM FLUSH GRADE TO TOP OF PIPE.

PROVIDE A 30" MINIMUM VERTICAL SEPARATION BETWEEN MAIN/SUBMAIN LINE(S) AND LATERAL LINE(S).

ALL TRENCHES SHALL BE BACKFILLED WITH CLEAN SOIL FREE OF DEBRIS & NOXIOUS WEEDS. TRENCHES SHALL BE COMPACTED TO A 90% STANDARD PROCTOR DENSITY, ASTM D698-78.

TYPICAL IRRIGATION MAIN TRENCHING DETAIL
N.T.S.

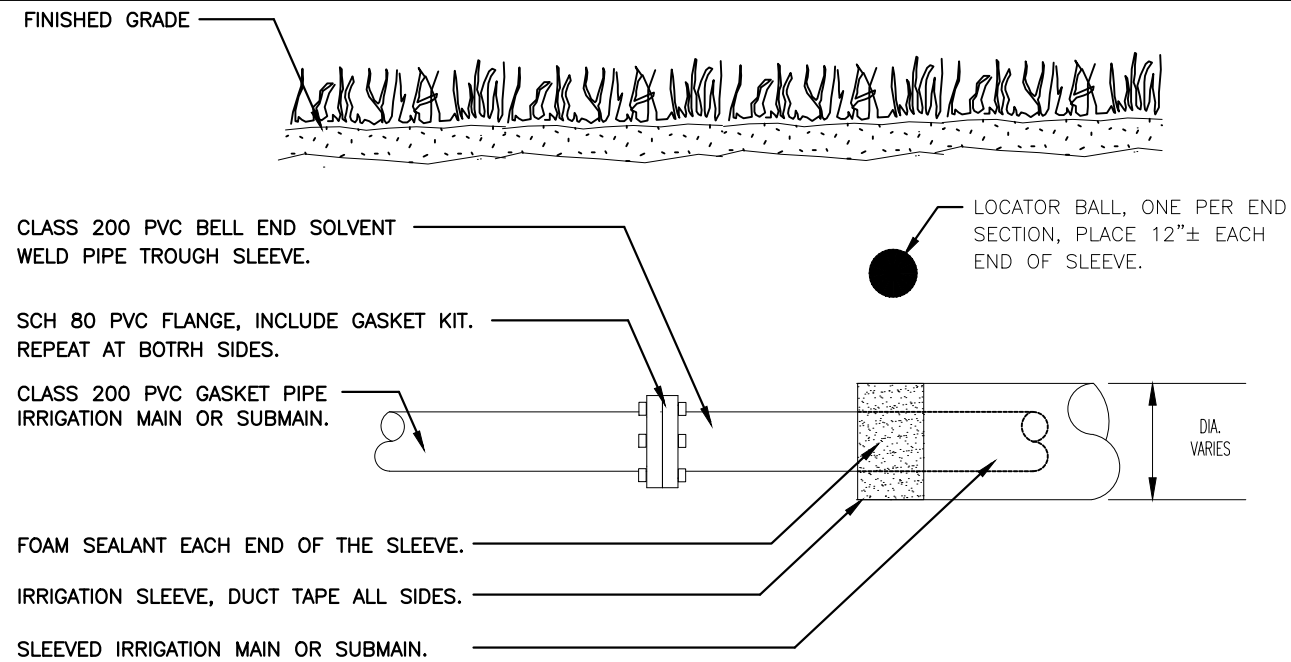

IRRIGATION SLEEVE SEALING DETAIL
N.T.S.



IN COORDINATION WITH:
Stantec
1821 VICTORIA AVENUE
FORT MYERS, FL 33901

PREPARED FOR:
LEE COUNTY
DEPARTMENT OF
TRANSPORTATION

LITTLETON ROAD
CONTRACT NO.: CN190114
LEE COUNTY, FL

SCALE:	
DATE:	DECEMBER 2021
PROJECT #:	
REV	DATE DESCRIPTION

IRRIGATION DETAILS & NOTES

DAYNA L. FENDORICK, RLA #0001224

SHEET #
IR-7

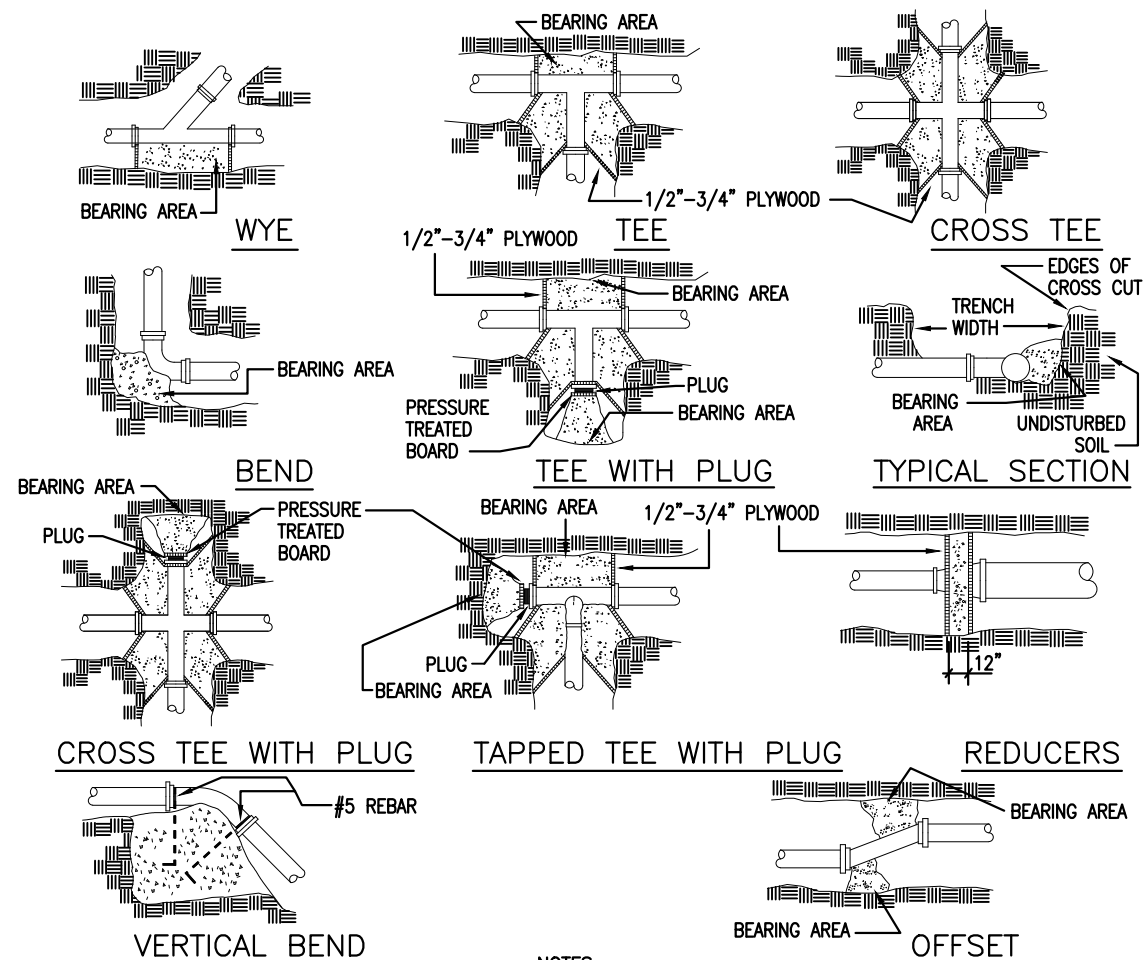

MINIMUM BEARING AREAS IN Sq.Ft. FOR THRUST BLOCKS.					
PIPE SIZE	TEES	90° BEND	45° BEND	22 1/2° BEND	WELVES & PLUGS
4"	1	1	1	1	1
6"	3	4	2	1	3
8"	5	7	4	2	5
10"	8	12	6	3	9
12"	12	16	9	5	12
16"	16	20	12	7	16
20"	24	20	17	10	24
24"	34	34	24	13	34

- NOTES:**
- ON BENDS AND TEES, EXTEND THRUST BLOCKS FULL LENGTH.
 - PLACE BOARD IN FRONT OF ALL PLUGS BEFORE POURING THRUST BLOCKS.
 - POUR THRUST BLOCKS AGAINST UNDISTURBED SOIL. WHERE TRENCH WALL HAS BEEN DISTURBED, EXCAVATE LOOSE SOIL & EXTEND THRUST BLOCK TO UNDISTURBED SOIL.
 - IN BACK FILLING, ANY MUCK ENCOUNTERED SHALL BE REMOVED & REPLACED WITH ACCEPTABLE MATERIAL.
 - BACK FILL MATERIAL SHALL NOT INCLUDE ROCK OR BOULDERS.
 - THRUST BLOCK AREAS BASED ON SOIL BEARING LOAD OF 2000 PSF. & LINE PRESSURE OF 150 PSI.
 - ALL IRRIGATION LINES LARGER THAN 2" ARE TO BE THRUST BLOCKED AS 4" SIZE.

**TYPICAL THRUST BLOCKS
INSTALLATION DETAIL**

N.T.S.

JUMBO VALVE BOX WITH LOCKABLE LID WITH 6" EXTENSION. SET ON BRICK SUPPORTS (4). PROVIDE NON-WOVEN FILTER FABRIC WITH 4" LAYER OF PEA GRAVEL ON TOP OF FILTER FABRIC. TAPE FILTER FABRIC TO EXTERIOR OF VALVE BOX WITH DUCT TAPE, PROVIDE A F.F. OVERLAP FROM BOTTOM OF BOX SHALL BE SET FLUSH AND LEVEL WITH GRADE.

1-1/4" MANUAL BRASS GATE VALVE. PROVIDE 6" LONG NIPPLE AT OUTLET.

VALVE INLET SIZED SCH 40 PVC THREADED NIPPLE CONNECTED TO VALVE. CUT OFF THREADED END AT FLANGED CONNECTION END AND SOLVENT WELD TO FLANGE.

FINISHED GRADE

10" ROUND VALVE BOX WITH 6" PVC SLEEVE DOWN TO VALVE. SLEEVE SHALL NOT BEAR ON VALVE.

2.5" SCH 80 PVC 45° LINE SIZED ELBOW CONNECTED TO FLANGED 2.5"x1-1/4" SCH 80 PVC FLANGE.

LINE SIZED GATE VALVE WITH FLANGED CONNECTIONS

LINE SIZED SCH 80 PVC FLANGED CONNECTIONS

IRRIGATION MAIN, REFER TO PLAN FOR SIZE(S).

NOTES:
ALL THREADED RODS, NUTS AND WASHERS SHALL BE STAINLESS STEEL.

OPEN AND CLOSE SLOWLY THE VALVES DURING FLUSHING. OPEN 2" VALVE FIRST, THEN OPEN LARGER VALVE. USE A MINIMUM TIME OF 30 SECONDS FOR OPENING OR CLOSING EACH VALVE UNDER PRESSURE.

**IRRIGATION MAIN/SUBMAIN BLOW-OFF
INSTALLATION DETAIL**

N.T.S.



IN COORDINATION WITH:
Stantec
1821 VICTORIA AVENUE
FORT MYERS, FL 33901

PREPARED FOR:
LEE COUNTY
DEPARTMENT OF
TRANSPORTATION

LITTLETON ROAD
CONTRACT NO.: CN190114
LEE COUNTY, FL

REV	DATE	DESCRIPTION

SCALE:
DATE: DECEMBER 2021
PROJECT #:

IRRIGATION DETAILS & NOTES

DAYNA L. FENDORICK, RLA #0001224

SHEET #
IR-8

C:\Users\tonya\OneDrive\Documents\CLEAN LINES\Urban Green Studio\LittletonExtension\Construction Docs\Littleton-Extension.dwg, 4/28/2023 9:54:31 AM

NON-POTABLE WATER
IDENTIFICATION PURPLE PLASTIC TAG.

IDENTIFICATION PLASTIC TAG,
YELLOW.

FINISH GRADE

CONTROL WIRES COILED
18' MIN. LENGTH PER WIRE.
TAPE TO INTAKE NIPPLE AND
TO MAIN LINE. PROVIDE WIRE
CONNECTORS.

COMPACTED CLEAN
BACKFILL

JUMBO VALVE BOX AS SPECIFIED
LEVEL & FLUSH WITH GRADE

ELECTRIC SOLENOID VALVE
AS SPECIFIED

1.5" SCH 40 PVC VALVE CONNECTING
NIPPLE. SCH 40 PVC THREADED
FITTINGS SHALL BE TIGHTENED TO
TORQUE RECOMMENDED BY
MANUFACTURER.

MANUAL GATE VALVE CONNECT TO
E.S.V. WITH SCH 40 PVC
NIPPLE.

BRICKS FOR SUPPORT
TAMP AND LEVEL

NON-WOVEN FILTER FABRIC
ATTACH TO VALVE BOX WITH
DUCT TAPE, PROVIDE 4" OVERLAP

4" OF 3/8" PEA GRAVEL, PROVIDE
2" GAP BETWEEN BOTTOM OF VALVE AND TOP
OF STONE. EXCAVATE PIT DEEP ENOUGH FOR GRAVEL DEPTH.

IRRIGATION CONTRACTOR SHALL FIELD DETERMINE NIPPLE LENGTHS.
MAINLINE OUTLET TEE, INTERCONNECTING NIPPLES AND ALL OTHER INTERCONNECTING
FITTINGS SHALL BE SIZED TO THE VALVES INLET OPENINGS.

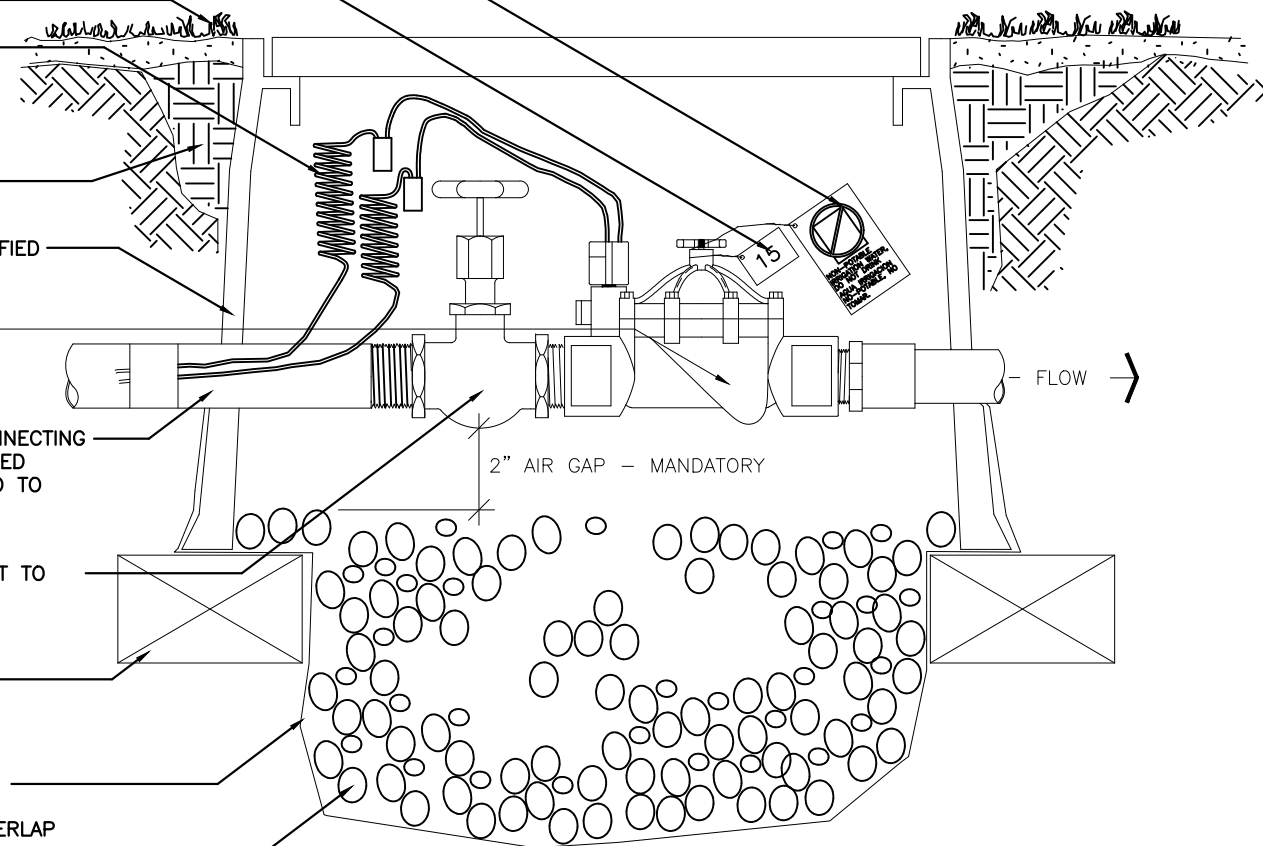

2" AIR GAP - MANDATORY

FLOW →

**ELECTRIC SOLENOID VALVE WITH MANUAL
GATE VALVE INSTALLATION DETAIL**

N.T.S.

STEP NO. 1.

STRIP WIRES AND APPLY
SCOTCHLOK Y ELECTRICAL
SPRING CONNECTOR IN A
CLOCKWISE DIRECTION.

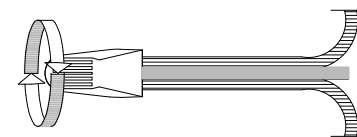

STEP NO. 2.

INSERT SPLICE TO BOTTOM
OF GEL-FILED TUBE.
VISUALLY CHECK TO MAKE
SURE SCOTCHLOK CONNECTOR
HAS BEEN PUSHED PAST THE
LOCKING FINGERS AND
IS SEATED ON THE
BOTTOM OF THE
TUBE.

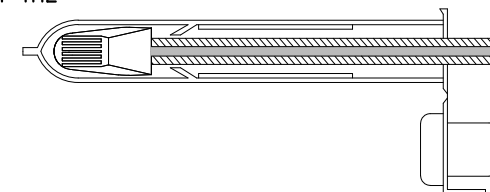

STEP NO. 3.

POSITION WIRES IN WIRE
CHANNELS AND
CLOSE INSULATOR
TUBE COVER.

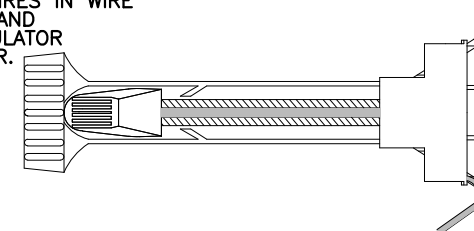

24 VOLT WIRE CONNECTION DETAIL

N.T.S.



P.O. BOX 111841, NAPLES, FLORIDA 34108
PHONE (239) 263-4629 FAX (239) 594-7091

IN COORDINATION WITH:
Stantec
1821 VICTORIA AVENUE
FORT MYERS, FL 33901

PREPARED FOR:
LEE COUNTY
DEPARTMENT OF
TRANSPORTATION

LITTLETON ROAD
CONTRACT NO.: CN190114
LEE COUNTY, FL

REV	DATE	DESCRIPTION

SCALE:
DATE: DECEMBER 2021
PROJECT #:

IRRIGATION DETAILS & NOTES

DAYNA L. FENDORICK, RLA #0001224

SHEET #
IR-9

C:\Users\tonya\OneDrive\Documents\CLEAN LINES\Urban Green Studio\LittletonExtension\Construction Docs\Littleton-Extension.dwg, 4/28/2023 9:55:04 AM

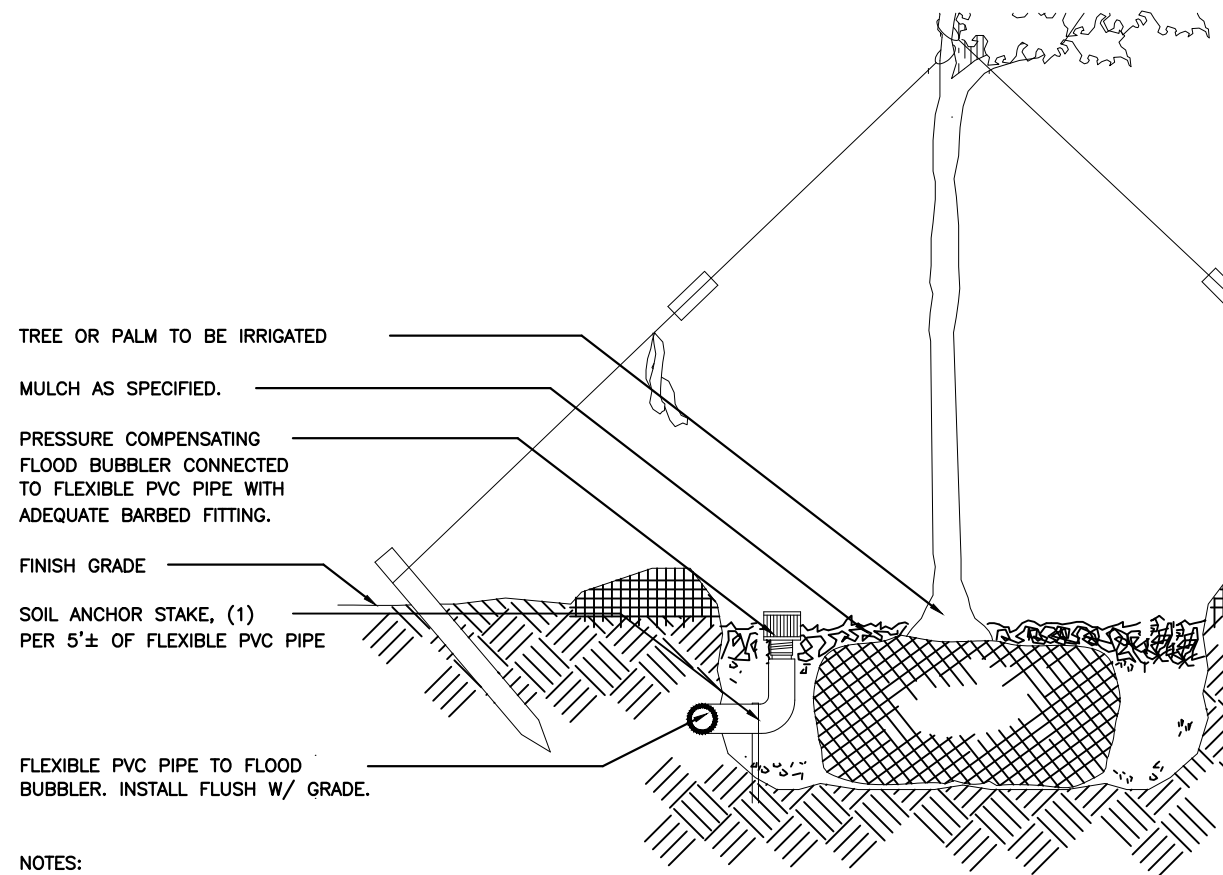

NOTES:
 REFER TO PLAN OR BUBBLER LEGEND FOR BUBBLER QUANTITIES & NOZZLE SIZE PER TREE/PALM.
 BUBBLER(S) IS/ARE TO BE INSTALLED ADJACENT TO ROOTBALL PERIMETER. DO NOT INSTALL BUBBLER ON TOP OF ROOTBALL, NEXT TO TRUNK; INSTALL AT EDGE OF ROOTBALL..
 ON SLOPING GROUNDS, INSTALL BUBBLER(S) DIRECTLY UPHILL FROM THE TREE/PALM ROOTBALL.

**IRRIGATION FLOOD BUBBLER FOR TREES
 OR PALMS INSTALLATION DETAIL**
 N.T.S.

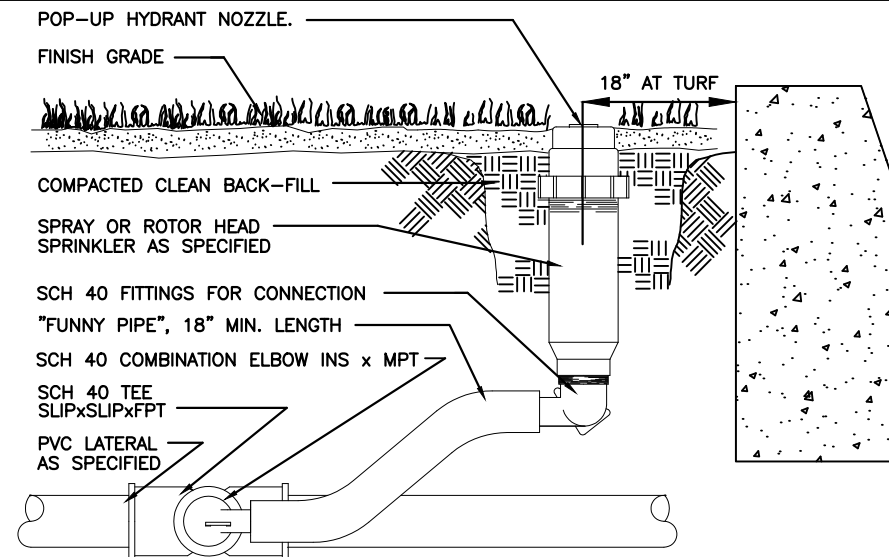

NOTES :
 NO SPRINKLER HEADS SHALL OCCUR WITHIN 18" FROM THE BACK OF CURB AT SOD AREAS, OR 24" FROM THE BACK OF CURB AT PLANTING AREAS.

**6" POP-UP SPRINKLER HEAD
 INSTALLATION DETAIL**
 N.T.S.

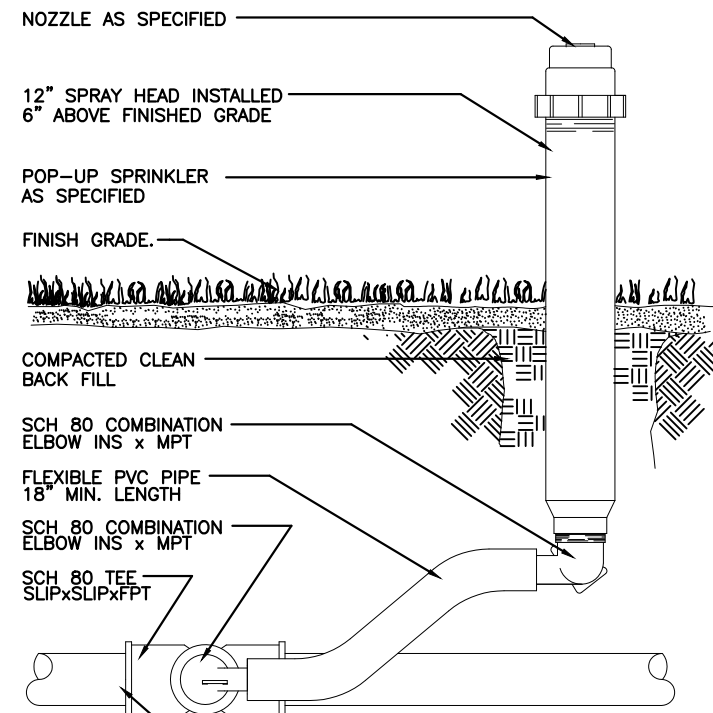

**12" POP-UP SPRAY HEAD
 INSTALLATION DETAIL**
 N.T.S.



IN COORDINATION WITH:
Stantec
 1821 VICTORIA AVENUE
 FORT MYERS, FL 33901

PREPARED FOR:
 LEE COUNTY
 DEPARTMENT OF
 TRANSPORTATION

LITTLETON ROAD
 CONTRACT NO.: CN190114
 LEE COUNTY, FL

SCALE:		
DATE:	DECEMBER 2021	
PROJECT #:		
REV	DATE	DESCRIPTION

IRRIGATION DETAILS & NOTES

DAYNA L. FENDORICK, RLA #0001224

SHEET #
IR-10

C:\Users\tonya\OneDrive\Documents\CLEAN LINES\Urban Green Studio\LittletonExtension\Construction Docs\Littleton-Extension.dwg, 4/28/2023 9:54:59 AM

DESIGN & APPLICATION CONTROL PARAMETERS

- ACREAGE TO IRRIGATE: 0.06 ACRES
- EVAPOTRANSPIRATION RATE AT PEAK TIME OF THE YEAR: 8.0"±
- CROPS TO IRRIGATE: SHRUB & GROUND COVER PLANTINGS WITH LOW WATER NEEDS.
- IRRIGATION APPLICATION METHODS TO BE IMPLEMENTED: CONVENTIONAL OVERHEAD SPRINKLER AND ROOT ZONE BUBBLER HYDRATION.
- TARGETED SYSTEM EFFICIENCY: SPRAY HYDRANTS, 70%; AND BUBBLER DISCHARGE HYDRANTS, 95%.
- REQUIRED WEEKLY APPLICATION RATE AT PEAK TIME OF THE YEAR: PLANTINGS, TREES & PALMS, 1.0"±.
- RECOMMENDED WATERING WINDOW: 2 NIGHTS PER WEEK, 4 HOURS PER NIGHT.
- FLOW DEMAND REQUIRED TO MEET RECOMMENDED WATERING WINDOW: TBD
- ESTIMATED HYDRANT APPLICATION RATES (MEASURED IN INCHES PER HOUR): FULL COVERAGE SPRAY HEADS, 1.50"; SINGLE ROW COVERAGE SPRAY HEADS, 1.0"; SIDESTRIP SPRAY NOZZLES, 2.0"±.
- RECOMMENDED APPLICATION RUN TIMES: SPRAY HEADS W/ SIDESTRIP NOZZLES AT SHRUBS AND GROUND COVER PLANTINGS, 2 NIGHTS PER WEEK, 20± MINUTES PER NIGHT; TREE/PALM BUBBLERS; TWO NIGHTS PER WEEK, 30 ± MINUTES PER NIGHT.

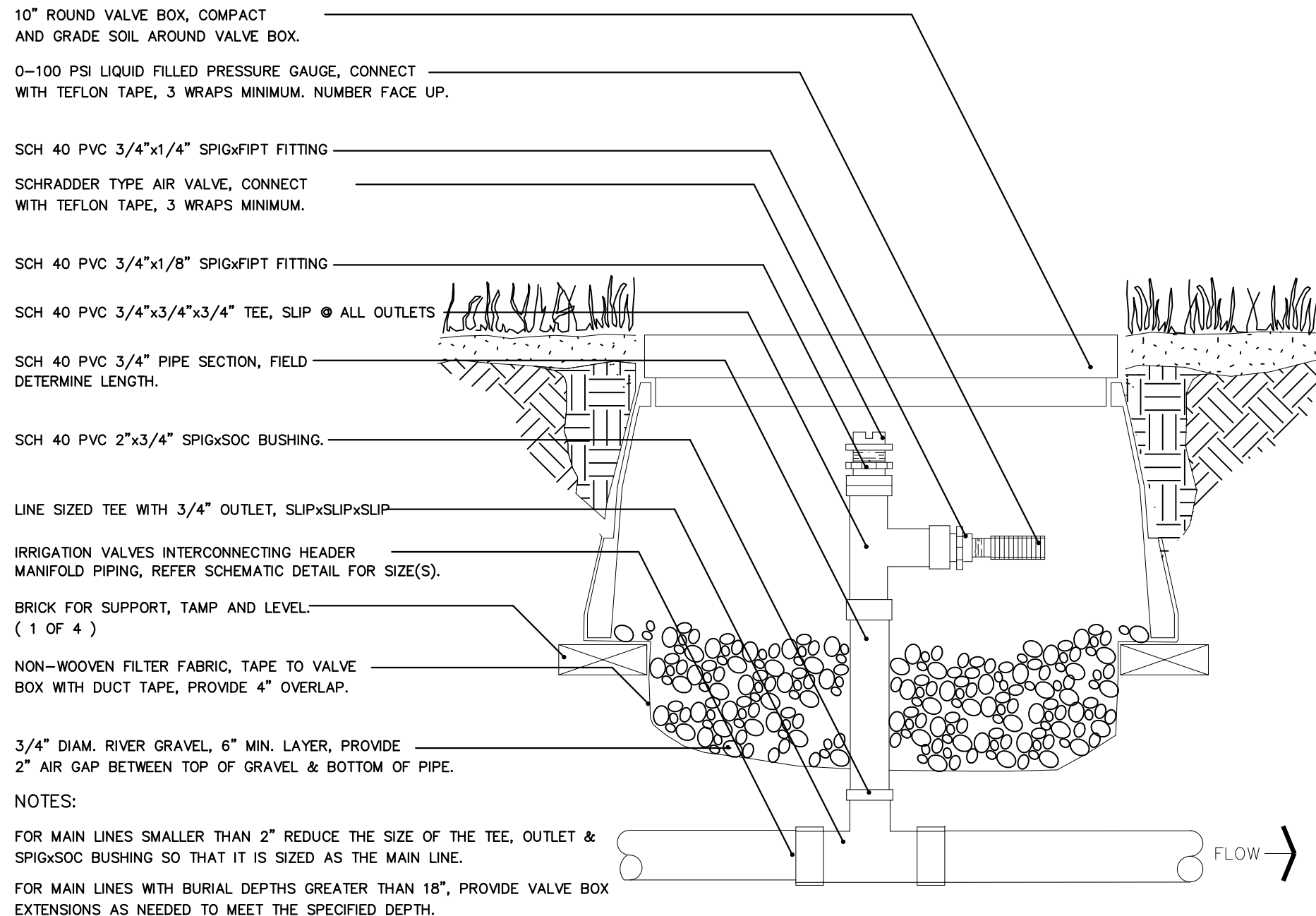

10" ROUND VALVE BOX, COMPACT
AND GRADE SOIL AROUND VALVE BOX.

0-100 PSI LIQUID FILLED PRESSURE GAUGE, CONNECT
WITH TEFLON TAPE, 3 WRAPS MINIMUM. NUMBER FACE UP.

SCH 40 PVC 3/4"x1/4" SPIGxFIPT FITTING

SCHRADDER TYPE AIR VALVE, CONNECT
WITH TEFLON TAPE, 3 WRAPS MINIMUM.

SCH 40 PVC 3/4"x1/8" SPIGxFIPT FITTING

SCH 40 PVC 3/4"x3/4"x3/4" TEE, SLIP @ ALL OUTLETS

SCH 40 PVC 3/4" PIPE SECTION, FIELD
DETERMINE LENGTH.

SCH 40 PVC 2"x3/4" SPIGxSOC BUSHING.

LINE SIZED TEE WITH 3/4" OUTLET, SLIPxSLIPxSLIP

IRRIGATION VALVES INTERCONNECTING HEADER
MANIFOLD PIPING, REFER SCHEMATIC DETAIL FOR SIZE(S).

BRICK FOR SUPPORT, TAMP AND LEVEL.
(1 OF 4)

NON-WOOVEN FILTER FABRIC, TAPE TO VALVE
BOX WITH DUCT TAPE, PROVIDE 4" OVERLAP.

3/4" DIAM. RIVER GRAVEL, 6" MIN. LAYER, PROVIDE
2" AIR GAP BETWEEN TOP OF GRAVEL & BOTTOM OF PIPE.

NOTES:

FOR MAIN LINES SMALLER THAN 2" REDUCE THE SIZE OF THE TEE, OUTLET &
SPIGxSOC BUSHING SO THAT IT IS SIZED AS THE MAIN LINE.

FOR MAIN LINES WITH BURIAL DEPTHS GREATER THAN 18", PROVIDE VALVE BOX
EXTENSIONS AS NEEDED TO MEET THE SPECIFIED DEPTH.

IRRIGATION MAIN LINE PRESSURE CHECK UNIT INSTALLATION DETAIL

N.T.S.



P.O. BOX 111841, NAPLES, FLORIDA 34108
PHONE (239) 263-4629 FAX (239) 594-7091

IN COORDINATION WITH:
Stantec
1821 VICTORIA AVENUE
FORT MYERS, FL 33901

PREPARED FOR:
LEE COUNTY
DEPARTMENT OF
TRANSPORTATION

LITTLETON ROAD
CONTRACT NO.: CN190114
LEE COUNTY, FL

REV	DATE	DESCRIPTION

SCALE:
DATE: DECEMBER 2021
PROJECT #:

IRRIGATION DETAILS & NOTES

DAYNA L. FENDORICK, RLA #0001224

SHEET #
IR-11

C:\Users\tonya\OneDrive\Documents\CLEAN LINES\Urban Green Studio\LittletonExtension\Construction Docs\Littleton-Extension.dwg, 4/28/2023 9:54:47 AM

IT IS THE RESPONSIBILITY OF THE INSTALLER TO CONNECT ALL ELECTRONIC IRRIGATION EQUIPMENT FOR WHICH HE IS RESPONSIBLE TO EARTH GROUND IN ACCORDANCE WITH ARTICLE 250 OF THE NATIONAL ELECTRIC CODE (NEC.) GROUNDING COMPONENTS WILL INCLUDE THE ITEMS DESCRIBED IN THE FOLLOWING PARAGRAPHS, AT A MINIMUM.

USE GROUNDING ELECTRODES THAT ARE UL LISTED OR MANUFACTURED TO MEET THE MINIMUM REQUIREMENTS OF ARTICLE 250-52 OF THE 1999 NEC. AT THE VERY MINIMUM, THE GROUNDING CIRCUIT WILL INCLUDE A COPPER CLAD STEEL GROUND ROD, A SOLID COPPER GROUND PLATE AND 100 POUNDS OF PowerSet EARTH CONTACT MATERIAL, AS DEFINED BELOW AND PER THE FOLLOWING DETAIL.

GROUND RODS ARE TO HAVE A MINIMUM DIAMETER OF 5/8" AND A MINIMUM LENGTH OF 10 FEET. THESE ARE TO BE DRIVEN INTO THE GROUND IN A VERTICAL POSITION OR AN OBLIQUE ANGLE NOT TO EXCEED 45 DEGREES AT A LOCATION 10 FEET FROM THE ELECTRONIC EQUIPMENT, THE GROUND PLATE, OR THE WIRES AND CABLES CONNECTED TO SAID EQUIPMENT, AS SHOWN IN THE DETAIL ABOVE. THE ROD IS TO BE STAMPED WITH THE UL LOGO [PAIGE ELECTRIC PART NUMBER 182007.] A 6 AWG SOLID BARE COPPER WIRE (ABOUT 12 FEET LONG) SHALL BE CONNECTED TO THE GROUND ROD BY THE INSTALLER USING A CADWELD GR1161G "ONE-SHOT" WELDING KIT [PAIGE ELECTRIC PART NUMBER 1820037.] THIS WIRE SHALL BE CONNECTED TO THE ELECTRONIC EQUIPMENT GROUND LUG AS SHOWN IN THE DETAIL ABOVE.

THE COPPER GROUNDING PLATE ASSEMBLIES [PAIGE ELECTRIC PART NUMBER 182199L] MUST MEET THE MINIMUM REQUIREMENTS OF ARTICLE 250-52(d) OF THE 1999 NEC. THEY ARE TO BE MADE OF A COPPER ALLOY INTENDED FOR GROUNDING APPLICATIONS AND WILL HAVE MINIMUM DIMENSIONS OF 4" X 96" X 0.0625". A 25-FOOT CONTINUOUS LENGTH (NO SPLICES ALLOWED UNLESS USING EXOTHERMIC WELDING PROCESS) OF 6 AWG SOLID BARE COPPER WIRE IS TO BE ATTACHED TO THE PLATE BY THE MANUFACTURER USING AN APPROVED WELDING PROCESS. THIS WIRE IS TO BE CONNECTED TO THE ELECTRONIC EQUIPMENT GROUND LUG AS SHOWN IN THE DETAIL. THE GROUND PLATE IS TO BE INSTALLED TO A MINIMUM DEPTH OF 30", OR BELOW THE FROST LINE IF IT IS LOWER THAN 30", AT A LOCATION 8 FEET FROM THE ELECTRONIC EQUIPMENT AND UNDERGROUND WIRES AND CABLES. TWO 50-POUND BAGS OF PowerSet [PAIGE ELECTRIC PART NUMBER 1820058] EARTH CONTACT MATERIAL MUST BE SPREAD SO THAT IT SURROUNDS THE COPPER PLATE EVENLY ALONG ITS ENTIRE LENGTH WITHIN A 6" WIDE TRENCH. SALTS, FERTILIZERS, BENTONITE CLAY, CEMENT, COKE, CARBON, AND OTHER CHEMICALS ARE NOT TO BE USED TO IMPROVE SOIL CONDUCTIVITY BECAUSE THESE MATERIALS ARE CORROSIVE AND WILL CAUSE THE COPPER ELECTRODES TO ERODE AND BECOME LESS EFFECTIVE WITH TIME.

INSTALL ALL GROUNDING CIRCUIT COMPONENTS IN STRAIGHT LINES. WHEN NECESSARY TO MAKE BENDS, DO NOT MAKE SHARP TURNS. TO PREVENT THE ELECTRODE-DISCHARGED ENERGY FROM RE-ENTERING THE UNDERGROUND WIRES AND CABLES, ALL ELECTRODES SHALL BE INSTALLED AWAY FROM SAID WIRES AND CABLES. THE SPACING BETWEEN ANY TWO ELECTRODES SHALL BE AS SHOWN IN THE DETAIL, SO THAT THEY DON'T COMPETE FOR THE SAME SOIL.

THE EARTH-TO GROUND RESISTANCE OF THIS CIRCUIT IS TO BE MEASURED USING A Megger, OR OTHER SIMILAR INSTRUMENT AND THE READING IS TO BE NO MORE THAN 10 OHMS. IF THE RESISTANCE IS MORE THAN 10 OHMS, ADDITIONAL GROUND PLATES AND PowerSet ARE TO BE INSTALLED IN THE DIRECTION OF AN IRRIGATED AREA AT A DISTANCE OF 10', 12', 14', ETC. IT IS REQUIRED THAT THE SOIL SURROUNDING COPPER ELECTRODES BE KEPT A MINIMUM MOISTURE LEVEL OF 15% AT ALL TIMES BY DEDICATING AN IRRIGATION STATION AT EACH CONTROLLER LOCATION. THE IRRIGATED AREA SHOULD INCLUDE A CIRCLE WITH A 10-FOOT RADIUS AROUND THE GROUND ROD AND A RECTANGLE MEASURING 1-FOOT BY 24- FEET AROUND THE PLATE.

ALL UNDERGROUND CIRCUIT CONNECTIONS ARE TO BE MADE USING AN EXOTHERMIC WELDING PROCESS UTILIZING PRODUCTS SUCH AS THE CADWELD "ONE-SHOT" KITS. SOLDER SHALL NOT BE ALLOWED TO MAKE CONNECTIONS. IN ORDER TO ENSURE PROPER IGNITION OF THE "ONE-SHOT", THE CADWELD T-320 IGNITER MUST BE UTILIZED [PAIGE ELECTRIC PART NUMBER 1820040]. THE 6 AWG BARE COPPER WIRES ARE TO BE INSTALLED IN AS STRAIGHT A LINE AS POSSIBLE, AND IF IT IS NECESSARY TO MAKE A TURN OR BEND IT SHALL BE DONE IN A SWEEPING CURVE WITH A MINIMUM RADIUS OF 8" AND A MINIMUM INCLUDED ANGLE OF 90-DEGREES. MECHANICAL CLAMPS SHALL BE PERMITTED TEMPORARILY DURING THE RESISTANCE TEST PROCESS, BUT ARE TO BE REPLACED WITH CADWELD "ONE-SHOT" KITS IMMEDIATELY THEREAFTER.

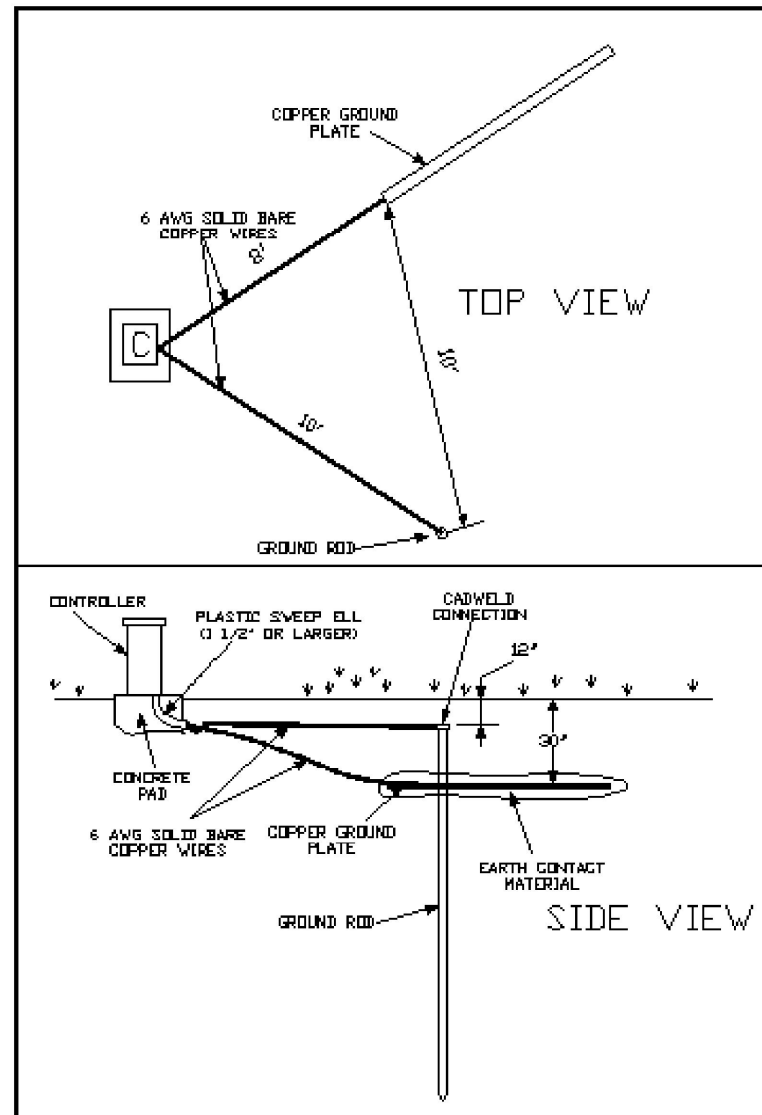

EARTH GROUNDING DETAIL



IN COORDINATION WITH:
Stantec
 1821 VICTORIA AVENUE
 FORT MYERS, FL 33901

PREPARED FOR:
 LEE COUNTY
 DEPARTMENT OF
 TRANSPORTATION

LITTLETON ROAD
 CONTRACT NO.: CN190114
 LEE COUNTY, FL

SCALE:	
DATE:	DECEMBER 2021
PROJECT #:	
REV	DATE DESCRIPTION

IRRIGATION DETAILS & NOTES

DAYNA L. FENDORICK, RLA #0001224

SHEET #
IR-12

C:\Users\tonya\OneDrive\Documents\CLEAN LINES\Urban Green Studio\LittletonExtension\Construction Docs\Littleton-Extension.dwg, 4/28/2023 9:54:21 AM

IRRIGATION SYSTEM SPECIFIC NOTES

- PIPING AND SOME ELEMENTS ARE SHOWN IN PAVED OR OTHER NON-LANDSCAPE DESIGNATED AREAS FOR GRAPHIC CLARITY ONLY, ACTUAL LOCATION SHALL BE WITHIN THE PROJECT'S LANDSCAPE DESIGNATED AREA.
- IRRIGATION CONTRACTOR, GENERAL CONTRACTOR AND OWNER SHALL FIELD DETERMINE THE FINAL LOCATIONS FOR IRRIGATION WELL, PUMP STATION AND CONTROLLER.
- THE RAIN SENSOR SHALL BE LOCATED IN AN OPEN AREA FREE OF VEGETATIVE OR STRUCTURAL OBSTRUCTION, CLEAR OF IRRIGATION COVERAGE.
- GENERAL CONTRACTOR SHALL PROVIDE SLEEVING.
- GENERAL CONTRACTOR SHALL PROVIDE DEDICATED ELECTRIC SERVICE POWER SUITABLE FOR THE PUMPS AND CONTROLLERS' OPERATION TO THE RESPECTIVE LOCATION(S).
- THE GENERAL CONTRACTOR SHALL PROVIDE SLEEVING NECESSARY AT LOCATIONS WHERE IT IS NEEDED AND WERE NOT KNOWN DURING THE DESIGN PROCESS. THE IRRIGATION CONTRACTOR MUST COORDINATE WITH THE GENERAL CONTRACTOR AND RECORD ALL SLEEVING LOCATIONS, INCLUDING SLEEVING SECTION MATERIAL, SIZE AND LENGTH.
- SLEEVING LENGTHS ARE SHOWN ONLY TO EDGE OF PAVED SURFACE FOR GRAPHIC CLARITY ONLY, ACTUAL LENGTH SHALL EXTEND: 5' BEYOND THE EDGE OF PAVEMENT AT DRIVEWAY/ROAD CROSSINGS; 24" AT SIDEWALK CROSSINGS.
- ALL SLEEVES MUST BE SEALED WITH A SEALING MEDIUM, AND ALL SLEEVES AT DRIVEWAY CROSSINGS MUST HAVE A SLEEVE LOCATING BALL PLACED 12" ABOVE EACH END.
- IRRIGATION CONTRACTOR SHALL BE RESPONSIBLE FOR COORDINATING WITH LANDSCAPE CONTRACTOR AND LOCATING ALL PLANT BEDLINE LOCATIONS PRIOR TO INSTALLING THE SPRINKLERS. NO RISER UNITS SHALL OCCUR WITHIN TURF OR LOW (18" OR LESS MATURE GROWTH HEIGHT) PLANTING AREAS. PROVIDE 12" HIGH POP-UP UNITS AT LOW PLANTINGS TAKE PLACE, OR AT TURF AREAS ADJACENT TO LOW PLANTING BEDLINES.
- PROVIDE BUBBLERS ONLY TO PROPOSED TREES AND PALMS. ALL BUBBLERS SHALL BE ZONED SEPARATE FROM OTHER HYDRANTS. PROVIDE (1) UNIT PER PROPOSED TREE/PALM. THE SIZE/VOLUME DISCHARGE OF THE BUBBLER NOZZLE SHALL BE ASSIGNED PER THE TREE/PALM BUBBLERS ASSIGNMENT TABLE/CHART.
- SOME PIPING SECTIONS ARE SHOWN GOING THROUGH EXISTING AND/OR PROPOSED TREES FOR GRAPHIC CLARITY ONLY. FIELD ADJUST THE PIPING LAYOUT SO THAT IT AVOIDS CONFLICT WITH EXISTING AND/OR PROPOSED TREES AND OTHER VEGETATION TO BE PROTECTED, PRESERVED OR INSTALLED.
- THE ELEMENTS MANUFACTURER AND MODEL NUMBER SPECIFIED MAY BE SUBSTITUTED FOR FOR OTHER ELEMENTS OF EQUAL VALUE, QUALITY AND OPERATING CHARACTERISTICS IF THE SPECIFIED UNITS ARE NOT AVAILABLE IN THE LOCAL/REGIONAL MARKET CORRESPONDING TO THE PROJECT LOCATION. ALL SUBSTITUTIONS MUST BE APPROVED BY URBAN GREEN STUDIO.



P.O. BOX 111841, NAPLES, FLORIDA 34108
PHONE (239) 263-4029 FAX (239) 594-7091

IN COORDINATION WITH:
 Stantec
1821 VICTORIA AVENUE
FORT MYERS, FL 33901

PREPARED FOR:
LEE COUNTY
DEPARTMENT OF
TRANSPORTATION

LITTLETON ROAD
CONTRACT NO.: CN190114
LEE COUNTY, FL

		SCALE:
		DATE: DECEMBER 2021
		PROJECT #:
REV	DATE	DESCRIPTION

IRRIGATION NOTES

DAYNA L. FENDORICK, RLA #0001224

SHEET #
IR-13

IRRIGATION NOTES

A. GENERAL NOTES

- The plans and drawings are diagrammatic of the work to be performed. The work shall be executed in a manner to avoid conflicts with utilities and other elements of construction, including landscape materials. Any and all deviations shall be brought to the attention of the owner or owners. The contractor shall not willfully install any aspect of the irrigation system as shown on the plans and drawings when it is obvious in the field that obstructions, grade differences, or discrepancies exist that might not have been known during the design of the irrigation system. In the event that notification of the conflict is not given to the representative, the contractor will assume full responsibility for all revisions.
- Irrigation system shall be installed in accordance with the plans, Irrigation System Specifications and all contract documents. Contractor shall comply with all prevailing local codes, ordinances and regulations.
- Check and verify all site conditions, including service utility locations, prior to trenching or digging. Coordinate all irrigation system construction with existing and/or new plantings to avoid conflict or interference with location of piping, sleeving, cables and service utilities. The irrigation contractor is responsible for coordinating installation with all other construction on site, especially landscape installation. Irrigation system is to be relocated at no additional cost for any conflict with landscape installation or any other site construction or existing conditions. All components that are not contained within the specific areas shown on the drawings will not be accepted. All piping and other components are to remain within the property of the OWNER.
- Where existing or new trees, light standards, signs, electronic controllers and/or other objects are an obstruction to an irrigation sprinkler's pattern, the component and piping shall be relocated as necessary to obtain proper coverage without damaging the obstruction. Landscape Architect or representative to determine whether obstruction occurs or not.
- Component spacings are maximum. Do not exceed spacings shown or noted on the plans. Component spacings may be adjusted to accommodate changes in terrain and planting layout as long as the modified spacings do not exceed the spacings shown in the plans. Unless shown otherwise, irrigation contractor shall provide 110% coverage.
- All materials and equipment shown shall be installed as detailed on the plans. If the drawings do not thoroughly describe the techniques to be used, the installer shall follow the installation methods/instructions recommended by their manufacturer.
- Irrigation contractor shall adjust all hydrants, controller and other devices to obtain specified operating characteristics, including coverage, operating pressure, flow rates and operation time, as indicated on the drawings and on the irrigation system Specifications. Adjust all sprinklers to avoid overthrow of water onto buildings, roadways, sidewalks or existing native vegetation.
- Contractor shall provide installation shop drawings and manufacturer product information for all irrigation components. All installations shall be as recommended by manufacturers. The quantities shown in the legends and symbol sheets shall not be used for bidding purposes. The contractor will be responsible for conducting a comprehensive take-off of materials to determine the actual quantities of material necessary to execute the work described on the plans and drawings.
- All trenches shall be backfilled with clean, debris-free materials. Clean sand shall be used for bedding material if parent soil cannot be adequately rid of rock and other extraneous debris. Pulling pipe shall be prohibited.
- All solvent welding shall be preceded by priming of the fittings and pipe as recommended by the manufacturer.
- Contractor to label/number all zone valve covers with corresponding controller zone number and isolation valve box covers with record drawing numbers. Provide tags to all valves as shown per details.

B. MAINLINE & PIPING

- All irrigation main(s) & submain(s) shall be 1120-1220 class 200 PVC gasketed pipe with DIP gasketed fittings. All pipes used downstream of each remote control valve shall be class 200 PVC solvent weld pipe, unless shown otherwise.
- The depth of all lines shall be as specified per plans and details. Measurements shall be from top of pipe(s) to finish grade. Contractor will be responsible for retrenching and relaying any pipe not meeting specified depth(s).
- All main lines & submain lines shall be installed with a tracing tape labeled "Non-potable Irrigation Main."
- All piping stubouts for future zone expansions shall have the capped end within a 6" valve box.

C. SLEEVING

- All roadway crossings, whether shown or not shall be sleeved as indicated per plans. The sleeving method shall be as indicated per plans. The casing shall be sized as per plans. A second casing designated (sch 40 pvc 2") for control controller valve wiring shall occur at all main & submain line crossings.
- Irrigation contractor shall coordinate with general contractor for the location of sleeve crossings whether shown or not. At no time will wiring share the same sleeve with main(s) or other piping.
- All sleeving shall extend (12") beyond the edge of of the surface requiring sleeving.
- All wiring sleeves shall be White Schedule 40 (2") or as sized per plan.

D. ISOLATION VALVES

- All isolation valves shall be brass or Ductile Iron Pipe. Isolation valves shall be sized as identified by symbols on the drawings, or by matching the size of the pipes they occur within.
- All isolation valves installed along the mainline shall be installed within a valve box. Refer to details and specifications for valve box sizes. Contractor shall provide valve box extensions when necessary.

IRRIGATION NOTES

E. QUICK COUPLER VALVES

- All quick coupler valves shall be brass. Quick coupler valves shall occur at locations shown on the plans, if applicable. Quick coupler valves shall be installed in 10" round valve boxes and as detailed on the drawings.
- The contractor shall furnish one (1) key and swivel assembly per (4) quick coupler valves.

F. CONTROL SYSTEM

- All controller(s) (each if applicable) will be installed in areas designated by the irrigation consultant or the landscape architect. In the event that no areas are designated, the irrigation contractor shall determine and field locate all controller(s) and rain sensor(s) location(s). Controller(s) shall be located in areas accessible to maintenance personnel. Rain sensor(s) shall be installed in open areas as per manufacturer recommendations. General contractor to provide dedicated 120 V. power in conduit to all controllers and provide electrical contractor to connect 120 V. power source to the controller.
- All controller(s) (each if applicable) will be grounded using (2) eight foot (8') copper clad rod with #6 braided copper wire. Copper clamps will be used to attach the wire to the rod. If another controller is utilized, an earth ground of five (5) five ohms or less shall be obtained on the grounding equipment.
- All controller(s) (each if applicable) will have a rain sensor and by-pass switch installed to meet state and local codes. Rain sensors and by-pass switches also will be installed in accordance to manufacturer's guidelines. Rain sensors to be Mini-Click II unless otherwise specified.
- It shall be the responsibility of the irrigation contractor to coordinate with other trades on site. Program or schedule the irrigation sequence for the irrigation system during construction and normal operation until final acceptance by the Landscape Architect. Controller & valve operation shall be chronological.

G. REMOTE CONTROL VALVES

- All control valves shall be installed as close as possible to the mainline(s) or submain(s) piping as possible. Control valves shall be type and size as specified herein and indicated on the drawings.
- Wire sizes for control valve connections to the controller will be as specified per plan and/or per decoder manufacturer specifications. The zone control valves' solenoid must be compatible with the control system decoders.
- All electrical splices shall be made in accordance to latest controller and decoder manufacturer specifications.

H. VALVE & SPLICE BOXES

- All valve boxes shall meet specifications, be sized & installed as shown and detailed herein. Top of valve boxes shall be 1"± above grade and level when installed. Contractor to reinstall and relevel boxes if soil settling occurs.
- Where possible and feasible install valve boxes within planting bedlines. No valve boxes shall be installed within: 3' of any sidewalk or other pedestrian used surface, 5' from any vehicular roadways, swale(s) or any other low point.

I. POP-UP SPRAYHEADS, TURF GEAR DRIVE HEADS & BUBBLERS

- All sprinkler heads will be installed and connected to lateral lines as per details. The smallest pipe size allowed to connect sprinkler heads shall be 1".
- All pop-up spray heads occurring in turf areas shall be 6" sprayheads. Rotor heads shall be those as specified herein. All sprinkler heads occurring within low plantings (24" or lower - average mature height) shall be 12" high pop-up sprinklers. All sprinkler heads occurring within plantings (24" or greater - average mature height) shall be installed on SCH 80 PVC risers and be "shrub" designated sprinklers, unless otherwise shown on the drawings.
- All trees and palms designated to have supplemental irrigation shall have pressure compensating flood type bubblers installed at the edge of the rootball. All tree/palm supplemental hydration bubbler nozzles shall have discharge rates as indicated in the plans. The irrigation contractor shall be responsible for coordinating with the landscape contractor to determine the total quantity of tree/palm bubblers needed, and also confirm their location. Tree/palm bubbler hydrants must be zoned separate hydrants.
- Sprayhead nozzle range shall be selected based on the spacings shown on the plan(s). The following guide lines shall be considered when selecting sprayhead nozzle ranges; 1'-4' spaces use side strip nozzles; 5'-8' spaces, 8' flat spray nozzles; 8.5'-10.5' spaces, 10' nozzles; 10.6'-12.5' spaces, 12' nozzles; 13.0'-16' spaces, 15' nozzles; 16.1'-18' spaces, 17' nozzles. The contractor shall consult with the Landscape Architect for arc adjustments if needed. The radius for rotor heads shall be adjusted to provide 10% better than "head to head" or 100% coverage.
- Hydrant nozzle selection shall be as shown on the plan. The irrigation Contractor shall provide all adjustments necessary so that the installed layout has compatible application rates within the subject zone. The Irrigation Contractor shall not willfully change specified nozzle sizes without calculating possible application rates.

J. INLINE TUBING DRIP IRRIGATION

- Drip irrigation components installation shall be in accordance to the latest product manufacture specifications, and also in accordance to the Drip Irrigation Specifications section presented per this set of plans.
- Drip irrigation inline tubing shall be installed in straight rows or rows that are parallel to an adjacent hardscape of landscape boundary located next to the area where the Drip Irrigation inline tubing is being laid.



P.O. BOX 111841, NAPLES, FLORIDA 34108
PHONE (239) 263-4629 FAX (239) 594-7091

IN COORDINATION WITH:
Stantec
1821 VICTORIA AVENUE
FORT MYERS, FL 33901

PREPARED FOR:
LEE COUNTY
DEPARTMENT OF
TRANSPORTATION

LITTLETON ROAD
CONTRACT NO.: CN190114
LEE COUNTY, FL

REV	DATE	DESCRIPTION
		SCALE:
		DATE: DECEMBER 2021
		PROJECT #:











IRRIGATION NOTES

DAYNA L. FENDORICK, RLA #0001224

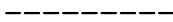
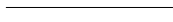



SHEET #
IR-14

C:\Users\tonya\OneDrive\Documents\CLEAN LINES\Urban Green Studio\LittletonExtension\Construction Docs\Littleton-Extension.dwg, 4/28/2023 9:54:26 AM

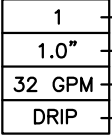

IRRIGATION SCHEDULE

SYMBOL	DESCRIPTION	EST. QTY.
	IRRIGATION WATER SOURCE: 4" IRRIGATION WELL W/ 5 HP VFD SUBMERSIBLE PUMP. FLOW CAPACITY; 50± GPM, REQUIRED MINIMUM PRESSURE, 50± PSI. WELL DEPTH & OTHER DRILLING SPECIFICS TO BE DETERMINED BY OTHERS BASED ON SITE CONDITIONS. THE PUMP STATION SHALL INCORPORATE PROTECTIVE, LOCKABLE FIBERGLASS ENCLOSURE. BY NAPLES ELECTRIC MOTORWORKS, OR EQUAL. ELECTRIC SERVICE REQUIREMENTS: 240 V SINGLE PHASE. <i>TO BE INSTALLED AS PART OF THE LITTLETON ROAD WIDENING PROJECT FROM CORBETT ROAD TO U.S. 41</i>	N.I.C. (FOR INFO ONLY)
	IRRIGATION CONTROLLER & RAIN SENSOR: TUCOR RKD+ CONTROLLER, TO BE LOCATED WITHIN THE PUMP STATION ENCLOSURE. TUCOR ET-300-W WEATHER STATION. <i>TO BE INSTALLED AS PART OF THE LITTLETON ROAD WIDENING PROJECT FROM CORBETT ROAD TO U.S. 41</i>	N.I.C. (FOR INFO ONLY)
	IRRIGATION SLEEVE: 4" SCH 40 PVC FOR MULTIPLE LINE CROSSINGS.	202 L.F.
	2" ELECTRIC CONDUIT: FOR CONTROL VALVE WIRING	1,175 L.F.
	IRRIGATION MAIN: 1120-1220 2-1/2" CLASS 200 PVC SOLVENT WELD PIPE WITH SCH 40 PVC INTERCONNECTING FITTINGS, PANTONE PURPLE 522C. INSTALLATION DEPTH, 30"±.	1,465 L.F.
	IRRIGATION LATERAL LINE: 1120-1220 CLASS 200 PVC SOLVENT WELD PIPE WITH SCH 40 PVC INTERCONNECTING FITTINGS, PANTONE PURPLE 522C. INSTALLATION DEPTH, 12". PIPE SIZES FROM 3/4" TO 1-1/4".	TBD
	IRRIGATION MAIN PRESSURE CHECK POINT: 0-100 PSI LIQUID FILLED PRESSURE GAUGE WITH OTHER ELEMENTS AS SHOWN PER DETAIL. REFER TO PRESSURE CHECK ASSEMBLY DETAIL	1
	IRRIGATION ZONE CONTROL VALVE: HUNTER ICV-151G, ICV SERIES 1-1/2" ELECTRIC SOLENOID VALVE WITH FLOW CONTROL HUNTER ICV-101G, ICV SERIES 1" ELECTRIC SOLENOID VALVE WITH FLOW CONTROL. INSTALL WITHIN A 14" x 19" x 12" CARSON VALVE BOX. REFER TO INSTALLATION DETAIL FOR OTHER COMPONENTS AND ASSEMBLY ILLUSTRATION. 1" OR 1-1/2".	3 2
	12" HIGH POP-UP SPRAY HEAD: HUNTER PROS-12, PRO-SPRAY SERIES 12" POP-UP SPRAY HYDRANT WITH SIDE STRIP OR END STRIP NOZZLE.	52
	TREE/PALM BUBBLER HYDRANT: RAINBIRD/HUNTER SR-00, SHRUB RISER NOZZLE ADAPTER W/ PC UMBRELLA BUBBLER NOZZLE. PROVIDE ONE UNIT PER DESIGNATED TREE/PALM. 1 GPM; .5 GPM; .25 GPM.	34
	6" HIGH POP-UP SPRAY HEAD: HUNTER PROS-6, PRO-SPRAY SERIES 6" POP-UP SPRAY HYDRANT. REFER TO PLAN FOR NOZZLE SIZE AND COVERAGE PATTERN.	9

TBD: TO BE DETERMINED BY CONTRACTOR

SYMBOL	DESCRIPTION	EST. QTY.
NO SYMBOL	IRRIGATION GROUND CONTROL WIRE: AWG 12 GAUGE SOLID COPPER INSULATED CONTROL WIRE SUITABLE FOR DIRECT BURIAL APPLICATIONS. PROVIDE DBR WIRE CONNECTORS IN ACCORDANCE TO CONTROLLER & SOLENOID MANUFACTURER'S SPECIFICATIONS. REFER TO BID TABLES FOR CONTROL WIRE GAUGE & COLORS.	TBD
NO SYMBOL	IRRIGATION ACTIVE CONTROL WIRE: AWG 14 GAUGE SOLID COPPER INSULATED CONTROL WIRE SUITABLE FOR DIRECT BURIAL APPLICATIONS. PROVIDE DBR WIRE CONNECTORS IN ACCORDANCE TO CONTROLLER & SOLENOID MANUFACTURER'S SPECIFICATIONS. REFER TO BID TABLES FOR CONTROL WIRE GAUGE & COLORS.	TBD
	PROPOSED 2-1/2" IRRIGATION MAIN ISOLATION VALVE: MATCO 514 SERIES 2-1/2" BRASS VALVE WITH THREADED CONNECTIONS, NON-RISING STEM, WHEEL TURN SQUARE NUT TURN HANDLE. INSTALL WITHIN A 10" ROUND BOX. PROVIDE 10" CORRUGATED PLASTIC ACCESS SLEEVE. REFER TO INSTALLATION DETAIL FOR OTHER COMPONENTS LISTING AND ASSEMBLY ILLUSTRATION.	1
	PROPOSED 2-1/2" IRRIGATION MAIN DOUBLE VALVE BLOW-OFF ASSEMBLY: 2-1/2" FLANGED CONNECTION VALVE WITH SQUARE NUT, WITH 1-1/4" SCH 80 PVC INTERCONNECTING FITTINGS, 1-1/4" MATCO 514 SERIES ISOLATION VALVE, VALVE BOXES, 10" CORRUGATED PLASTIC ACCESS SLEEVE. REFER TO INSTALLATION DETAIL.	1
	<ul style="list-style-type: none"> 1 VALVE/CONTROLLER NUMBER 1.0" VALVE SIZE 32 GPM ZONE FLOW DEMAND DRIP ZONE IRRIGATION TYPE 	
NO SYMBOL	TUCOR LD-050 SINGLE STATION DECODERS - PROVIDE ONE PER CONTROL VALVE.	5
	TUCOR SP-100 SURGE PROTECTOR WITH PAIGE 182199IC GROUND PLATE 4" x 8" SOLID COPPER WITH 25' 0 6 AWG GREEN WIRE, 8' GROUND ROD AND CADWELD "ONE SHOT". INSTALL PER MANUFACTURER'S SPECIFICATIONS AND DETAILS.	3

BUBBLERS REFERENCE TABLE

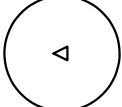
SYMBOL	DESCRIPTION	BUBBLER NOZZLE SIZE & QTY.
	ALEXANDER PALM (PE)	(1) 1402, .5 GPM BUBBLER PER PALM
	FLORIDA SILVER PALM (CA)	(1) 1401, .25 GPM BUBBLER PER PALM
	EAGLESTON HOLLY TREE (IA)	(1) 1404, 1.0 GPM BUBBLER PER TREE



IN COORDINATION WITH:
Stantec
1821 VICTORIA AVENUE
FORT MYERS, FL 33901

PREPARED FOR:
LEE COUNTY
DEPARTMENT OF
TRANSPORTATION

LITTLETON ROAD
CONTRACT NO.: CN190114
LEE COUNTY, FL

SCALE:	
DATE:	DECEMBER 2021
PROJECT #:	
REV	DATE DESCRIPTION

IRRIGATION SCHEDULE

SHEET #
IR-15

DAYNA L. FENDORICK, RLA #0001224